

Scientific expectations and challenges for Planck and future CMB experiments

Carlo Baccigalupi, SISSA, Trieste, Italy



Outline

- CMB physics
- Status of CMB observations
- Challenges for future CMB
- The science goals of the Planck satellite
- Conclusions, ☹/☺

CMB physics



CMB: where and when?

- Opacity: $\lambda = (n_e \sigma_T)^{-1} \ll H^{-1}$
- Decoupling: $\lambda \approx H^{-1}$
- Free streaming: $\lambda \gg H^{-1}$
- Cosmological expansion, constants and baryon abundance conspire to activate decoupling about 300000 years after the Big Bang, at about 3000 K photon temperature

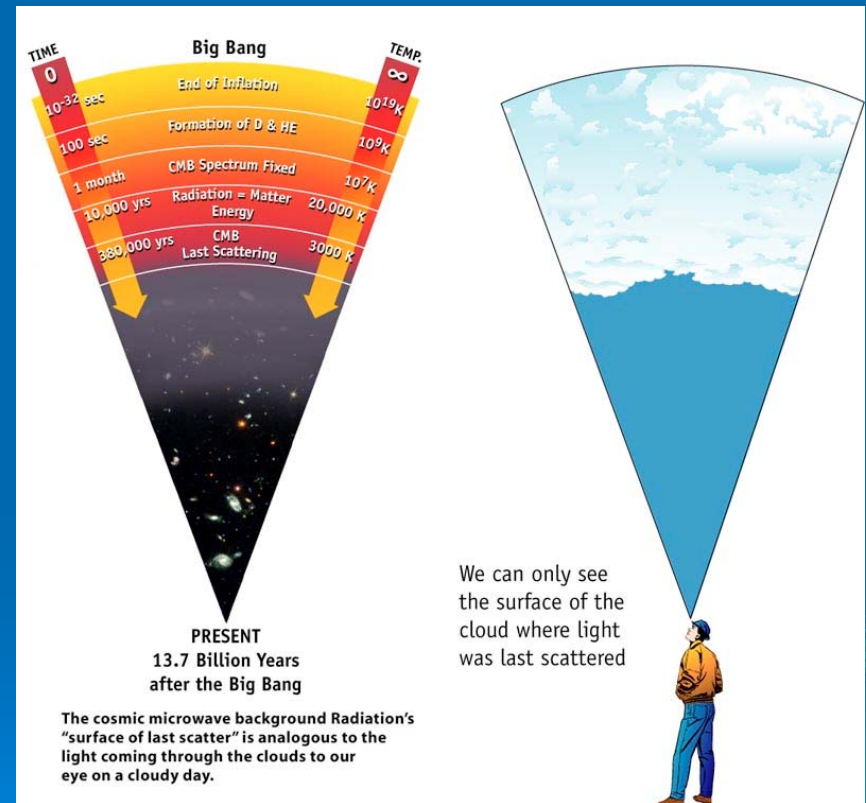

CMB anisotropy: phenomenology

- Primordial perturbations in the curvature affect all cosmological species
- Perturbation evolution for all components dictated by the cosmic expansion
- The anisotropy in the CMB represents the snapshot of cosmological perturbations in the photon component only, at decoupling time

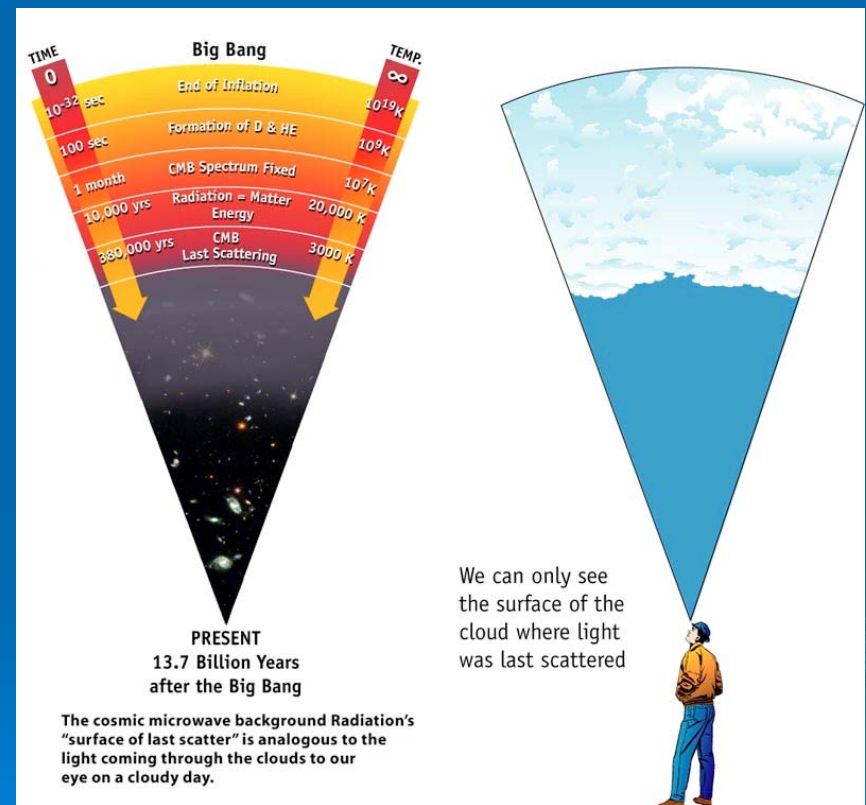

CMB physics: Boltzmann equation

$$\frac{d \text{ photons}}{dt} = \text{metric} + \text{Compton scattering}$$

$$\frac{d \text{ baryons+leptons}}{dt} = \text{metric} + \text{Compton scattering}$$

CMB physics: Boltzmann equation

d neutrinos

$$\frac{d \text{ neutrinos}}{dt} = \text{metric} + \text{weak interaction}$$

d dark matter

$$\frac{d \text{ dark matter}}{dt} = \text{metric} + \text{weak interaction (?)}$$

metric = photons + neutrinos + baryons + leptons + dark matter

CMB physics: metric

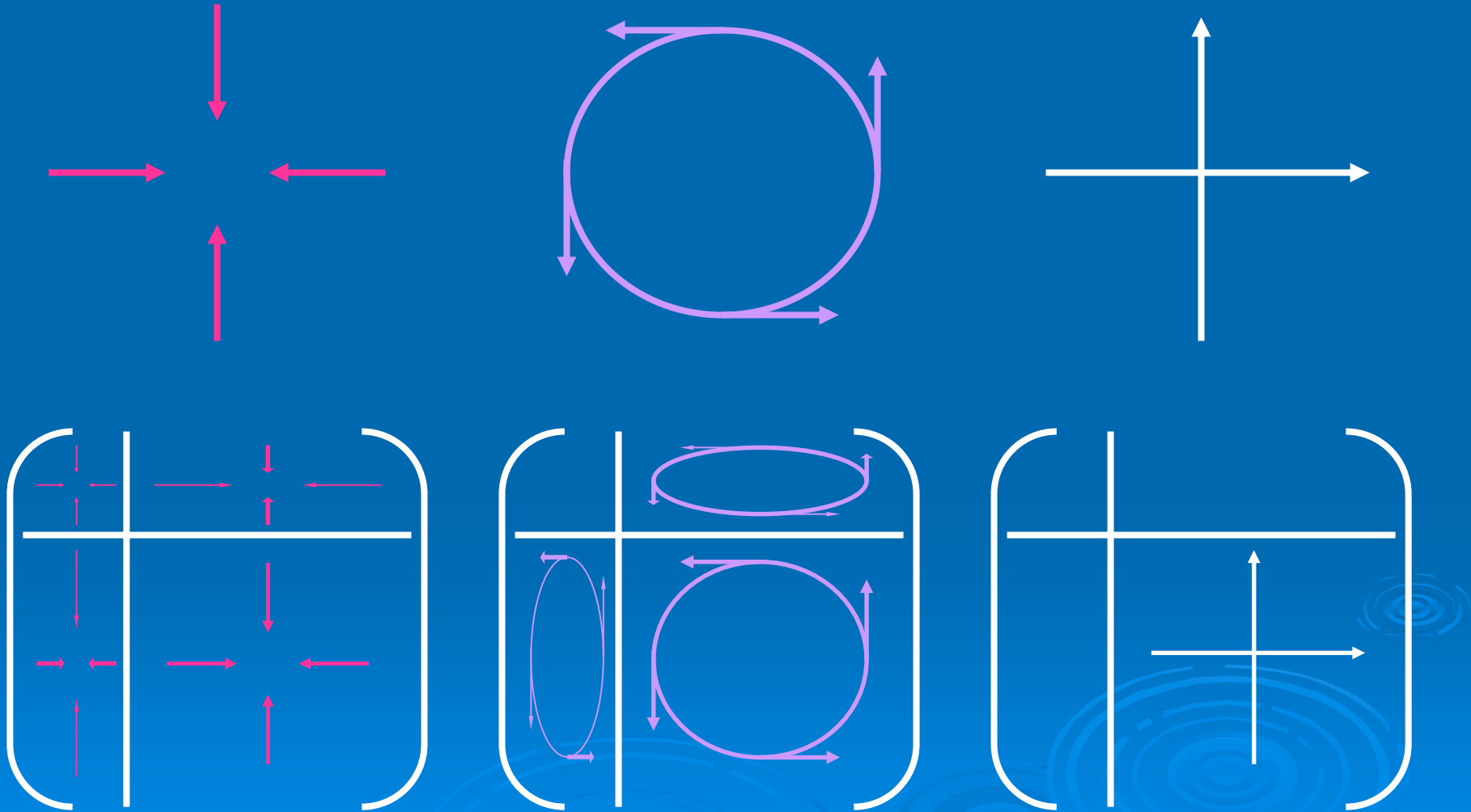

CMB Physics: Compton scattering

- Compton scattering is anisotropic
- An anisotropic incident intensity determines a linear polarization in the outgoing radiation
- At decoupling that happens due to the finite width of last scattering and the cosmological local quadrupole

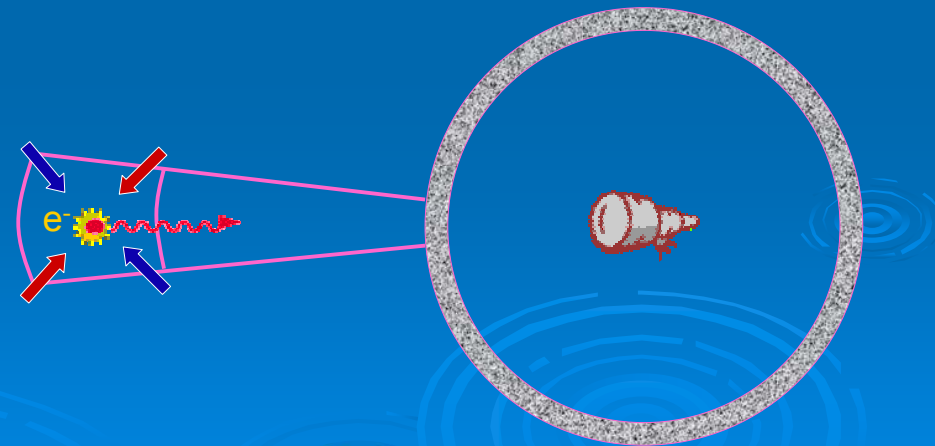
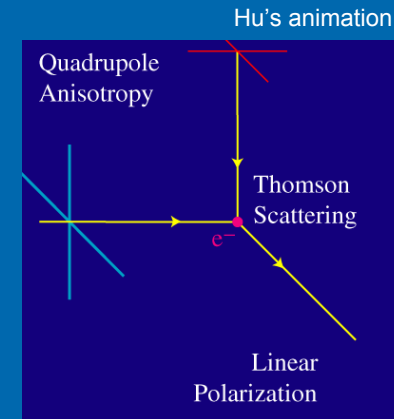

CMB anisotropy: total intensity

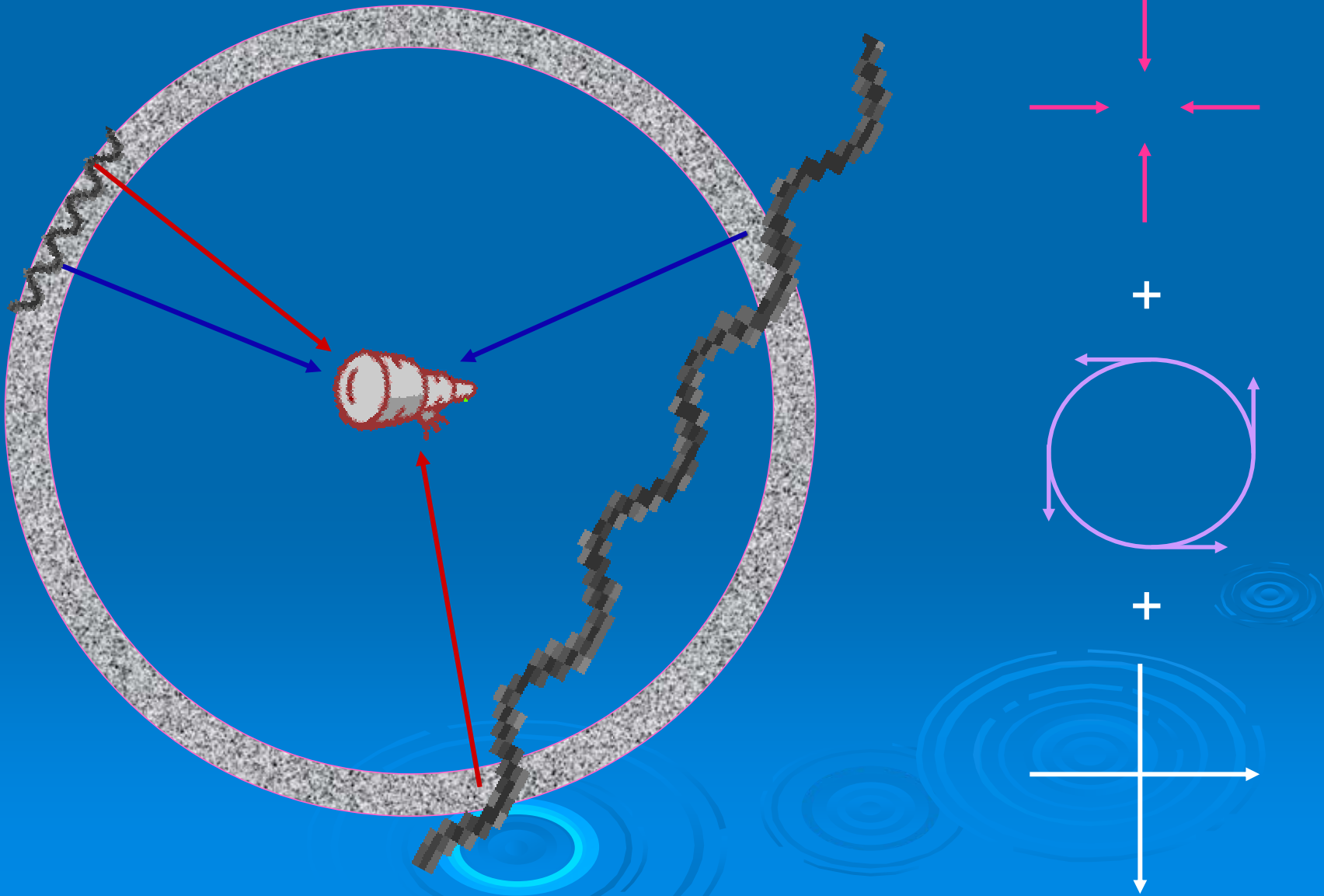

CMB anisotropy: polarization

Curl (B):

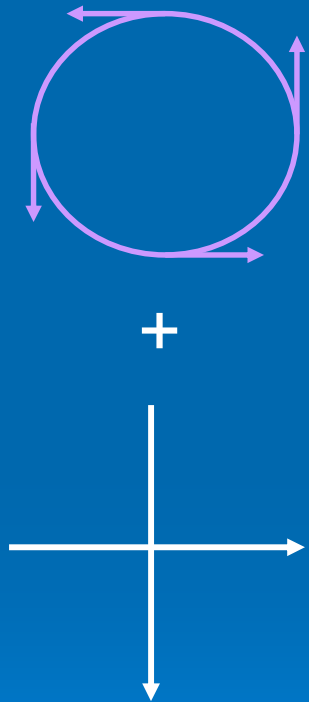

Gradient (E):

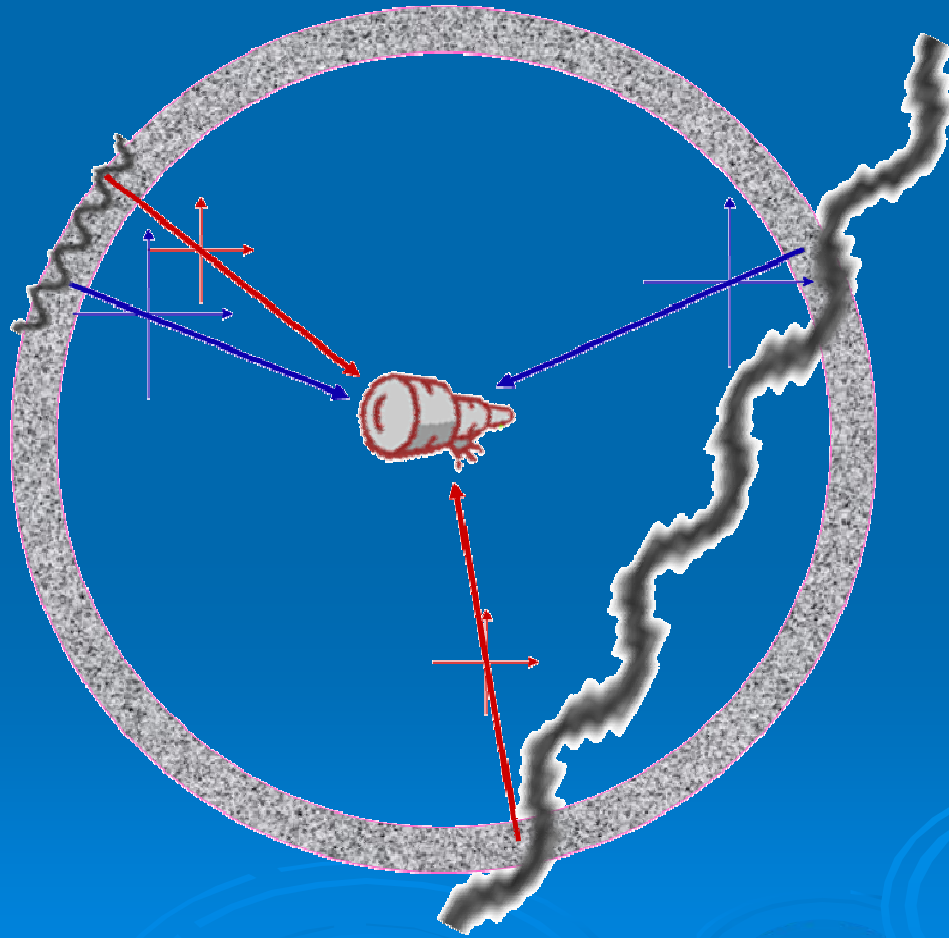
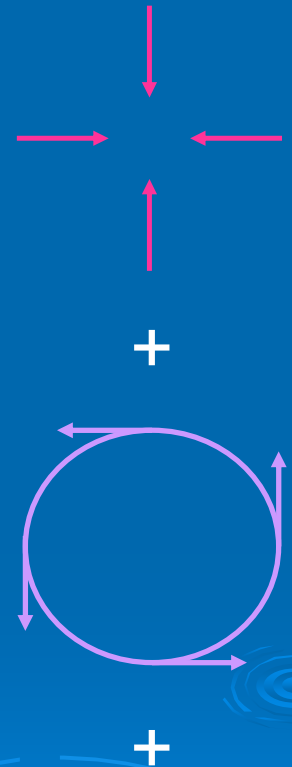

CMB anisotropy: reionization

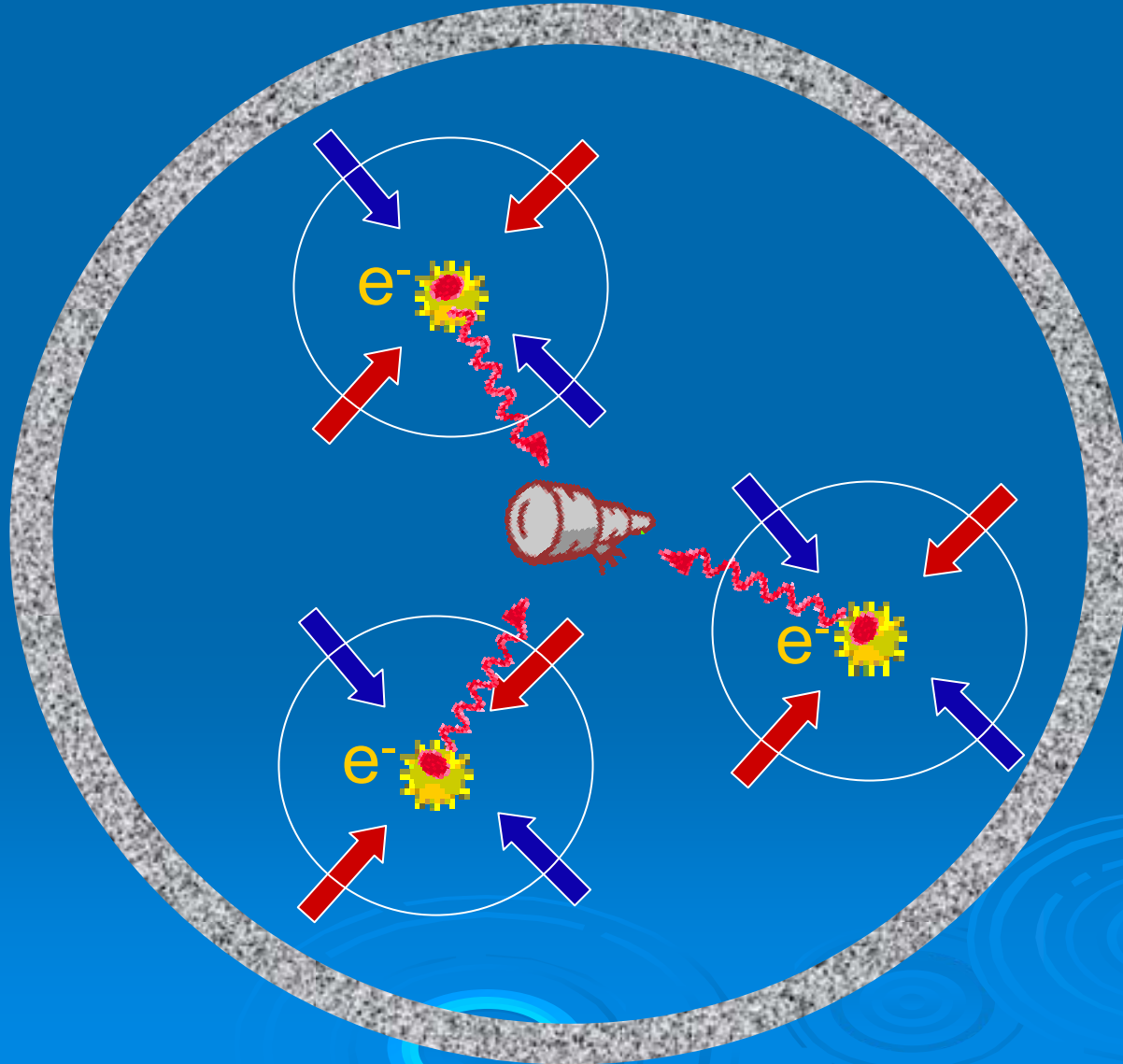

CMB anisotropy: lensing

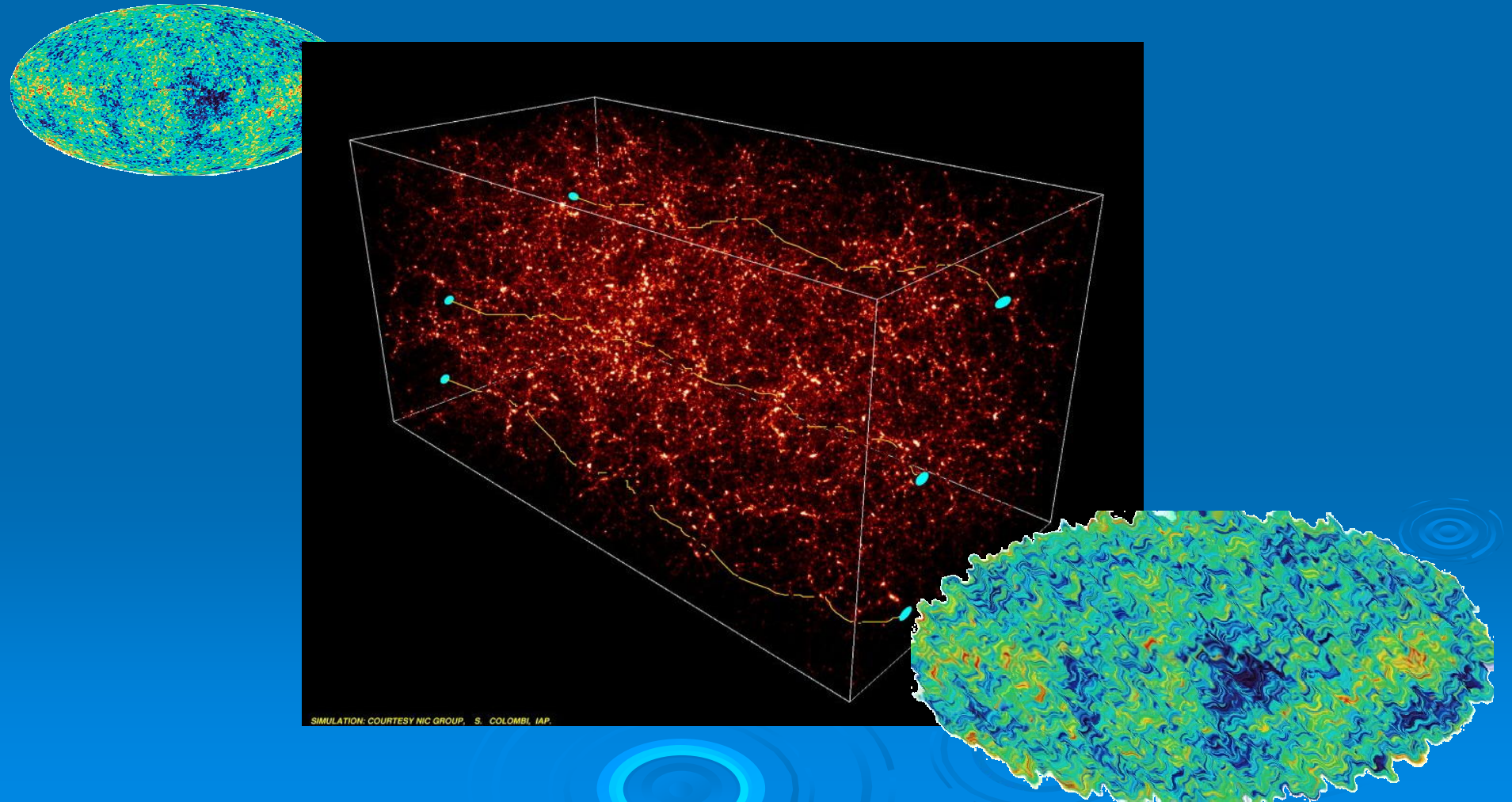

CMB anisotropy: lensing

E
B

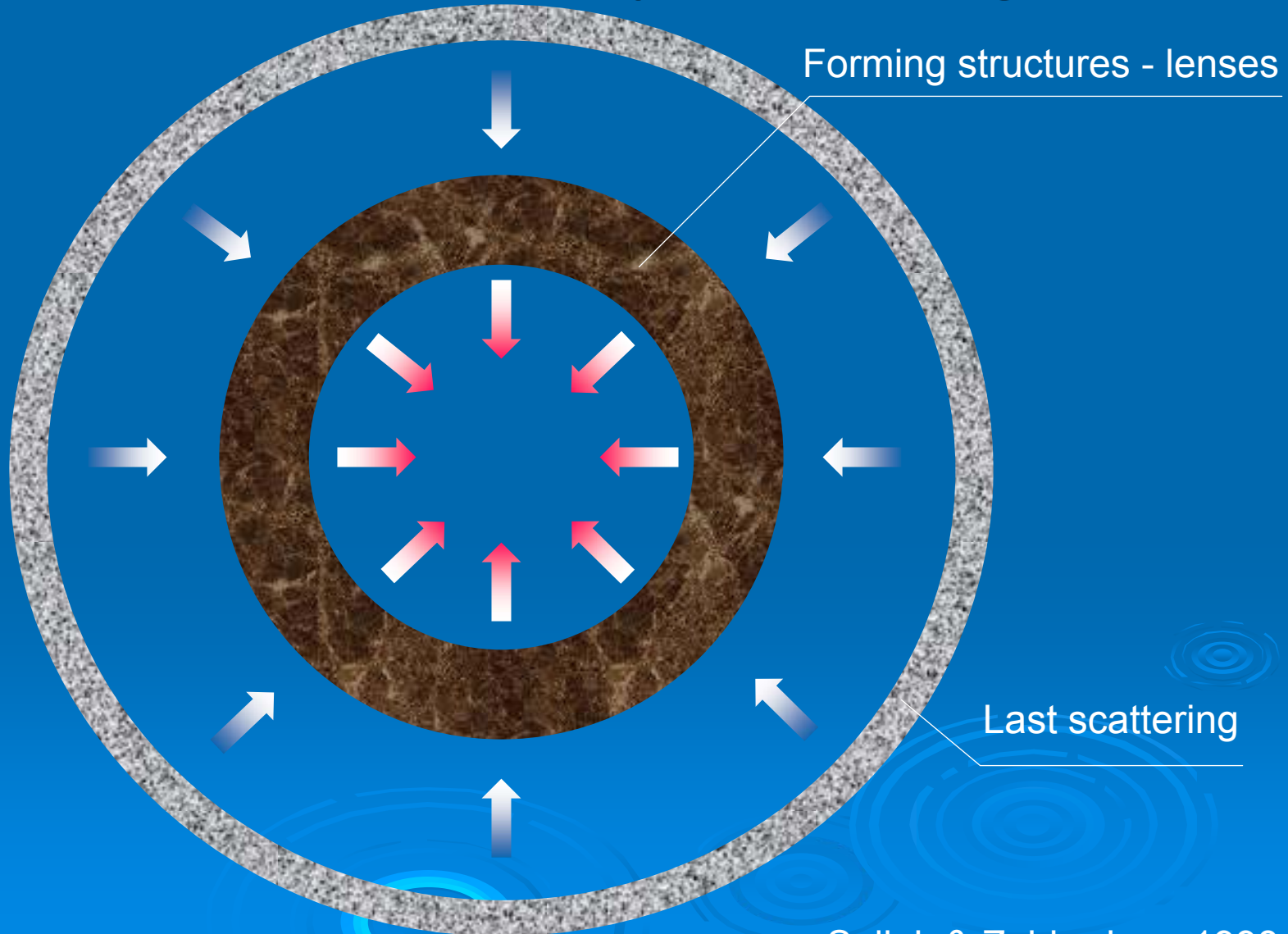

CMB anisotropy: lensing

E
B

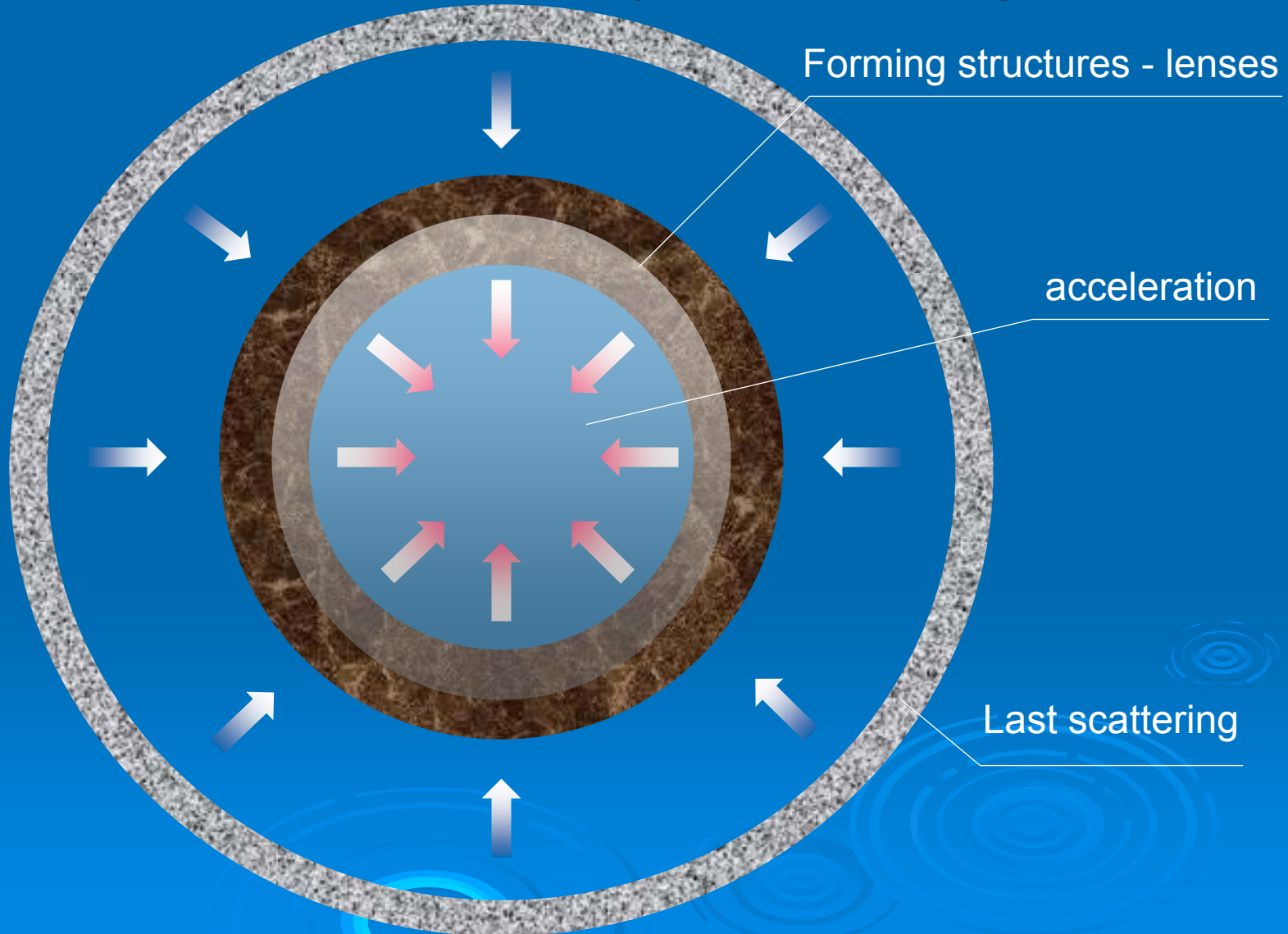

Status of CMB observations



CMB anisotropies

$T(n), Q(n), U(n), V(n)$

spherical harmonics

$a_{lm}^T, a_{lm}^E, a_{lm}^B$

information compression

$$C_l = \sum_m |a_{lm}^{T,E,B}|^2 / 2(l+1)$$

CMB angular power spectrum

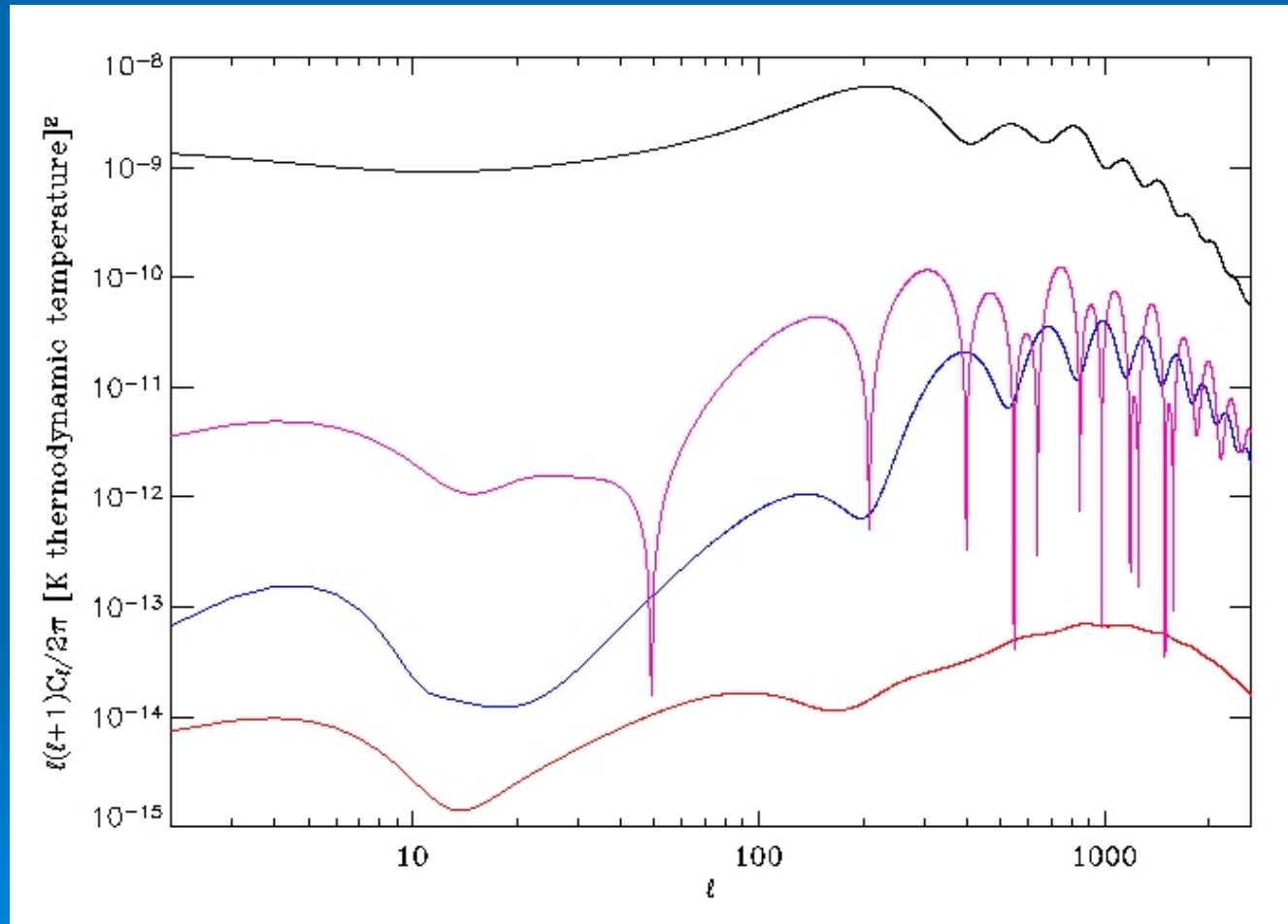

Angle $\approx 200/\ell$ degrees

CMB angular power spectrum

Acoustic oscillations

Primordial power

Reionization

Lensing

Gravity waves

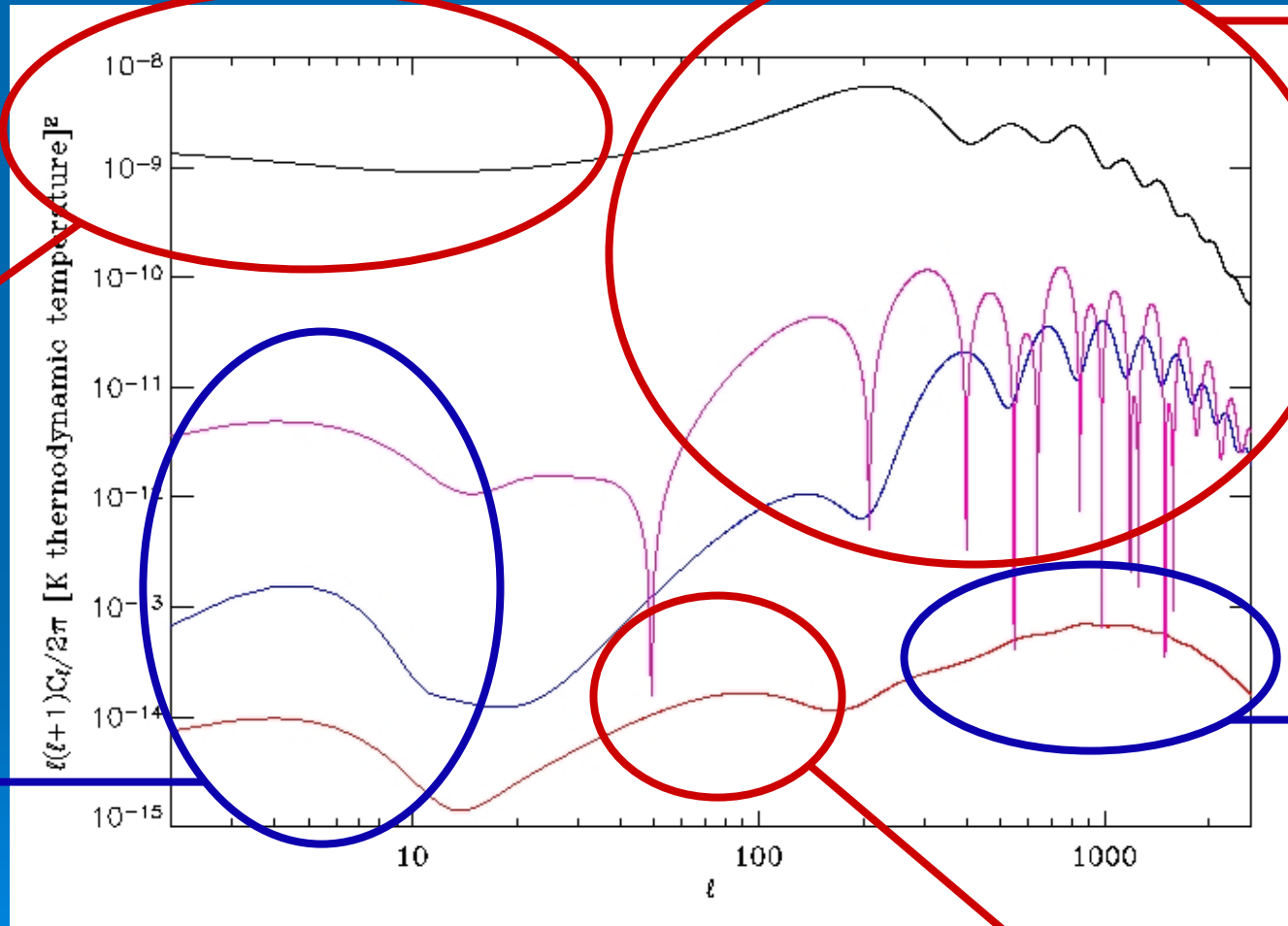

Angle $\approx 200/l$ degrees

WMAP first year

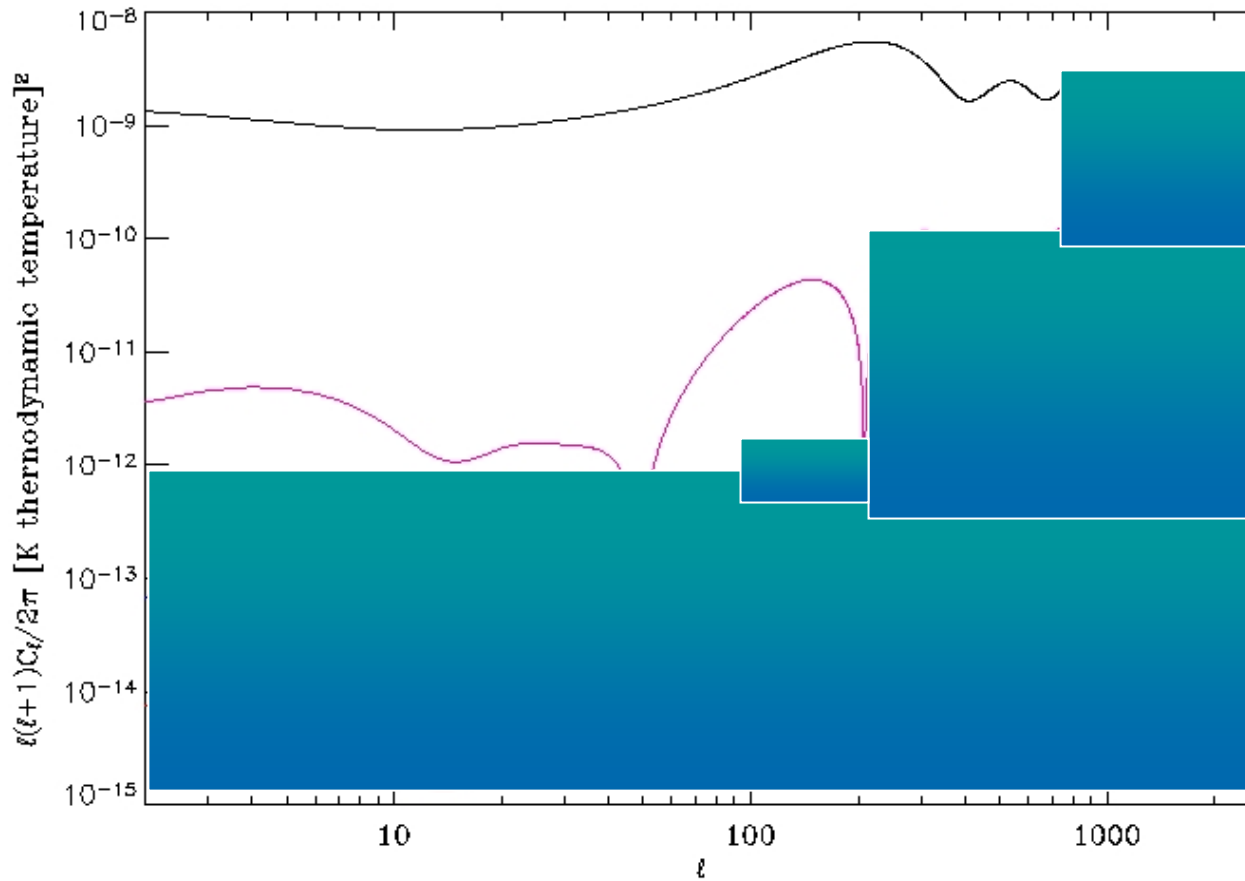

Angle $\approx 200/\ell$ degrees

WMAP third year

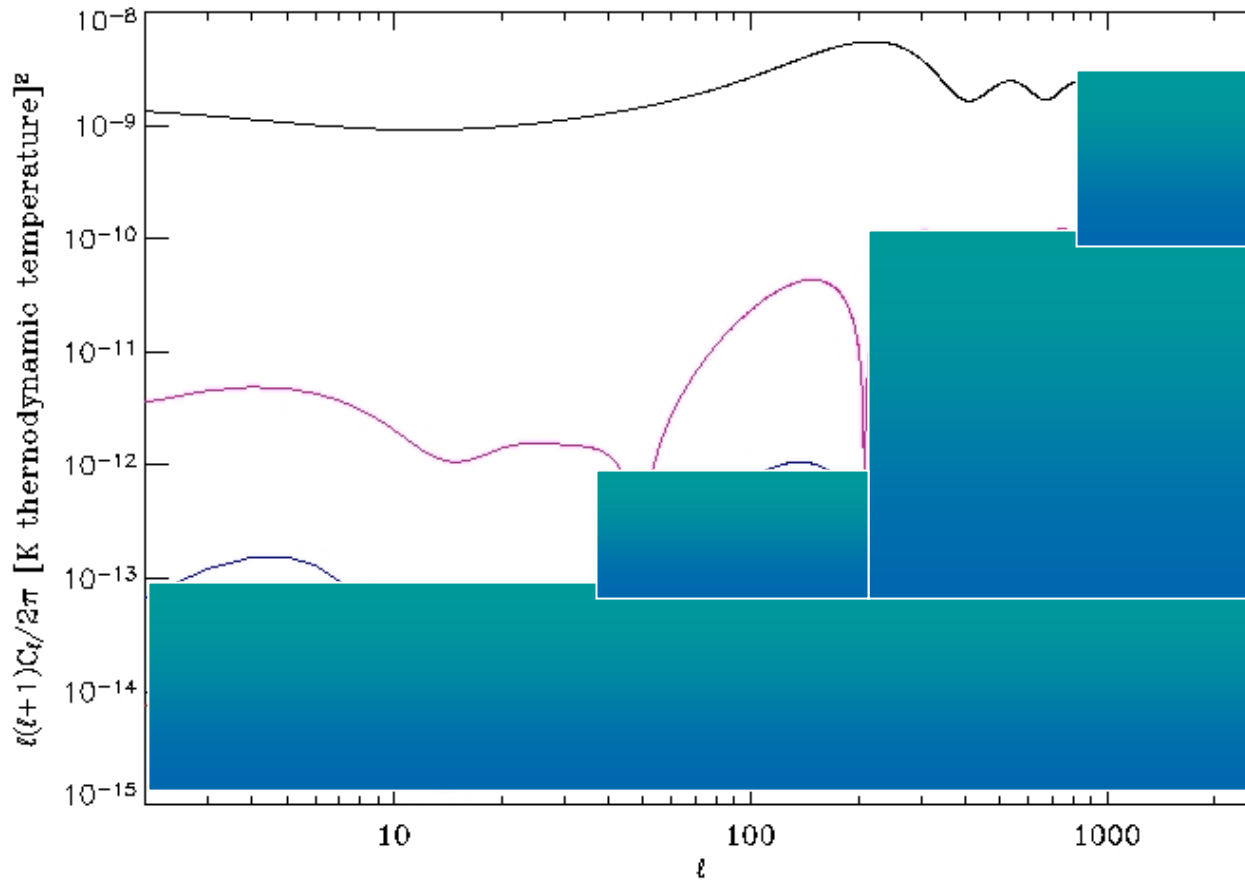

Angle $\approx 200/\ell$ degrees

CMB angular power spectrum

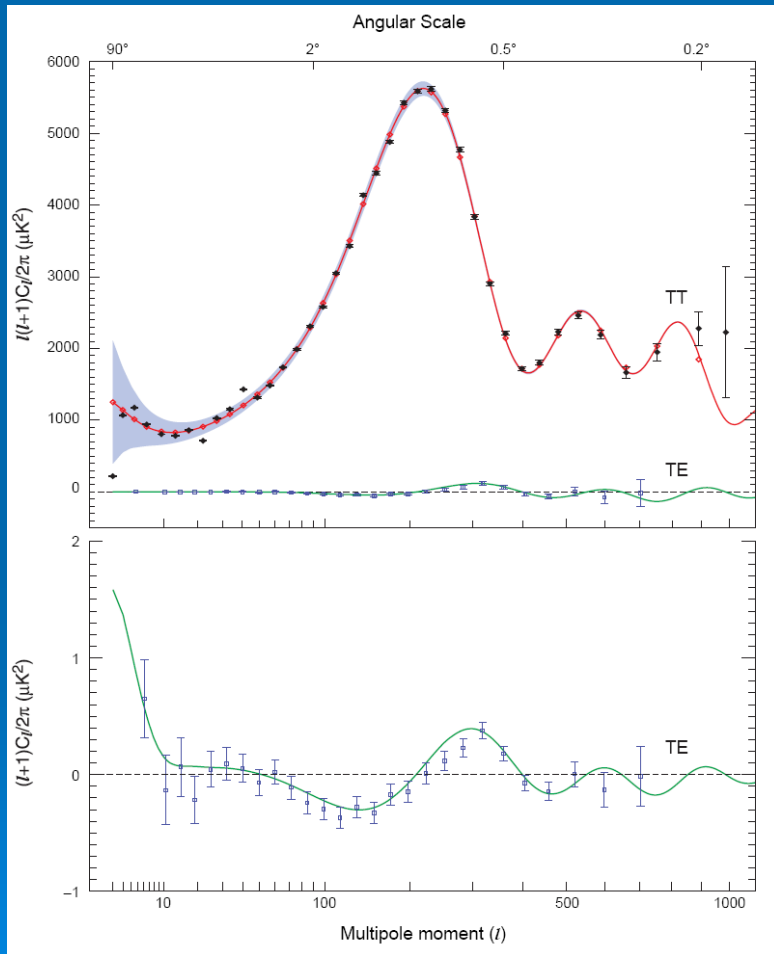

WMAP

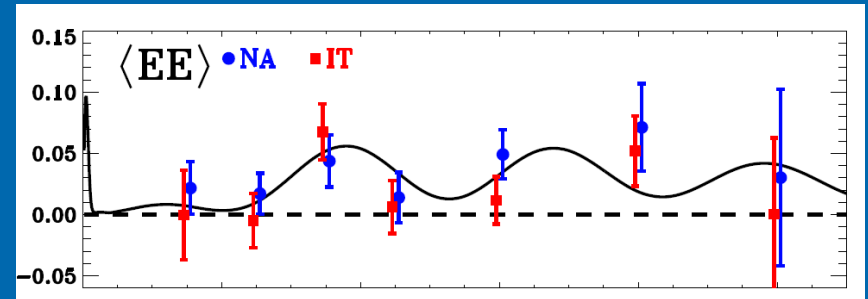

boomerang

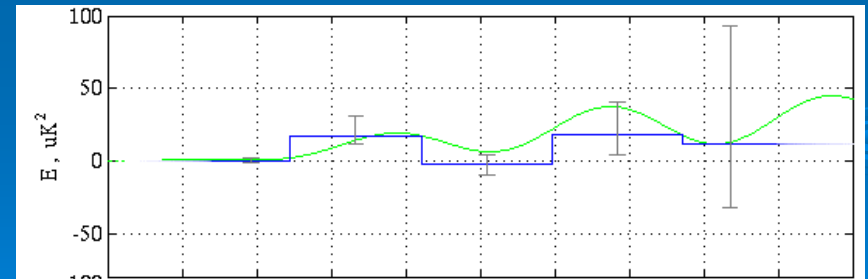

dasi

Cosmological concordance model

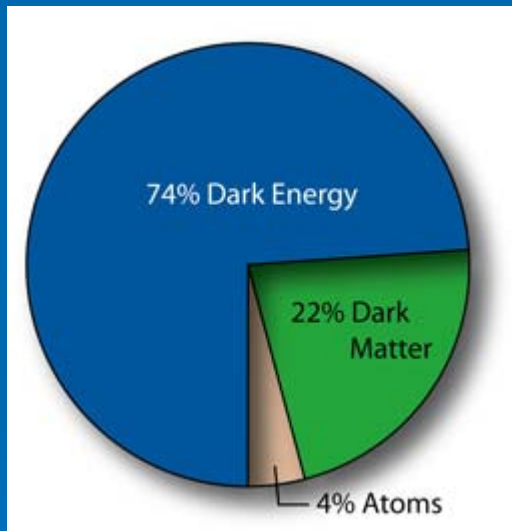

Cosmological concordance model

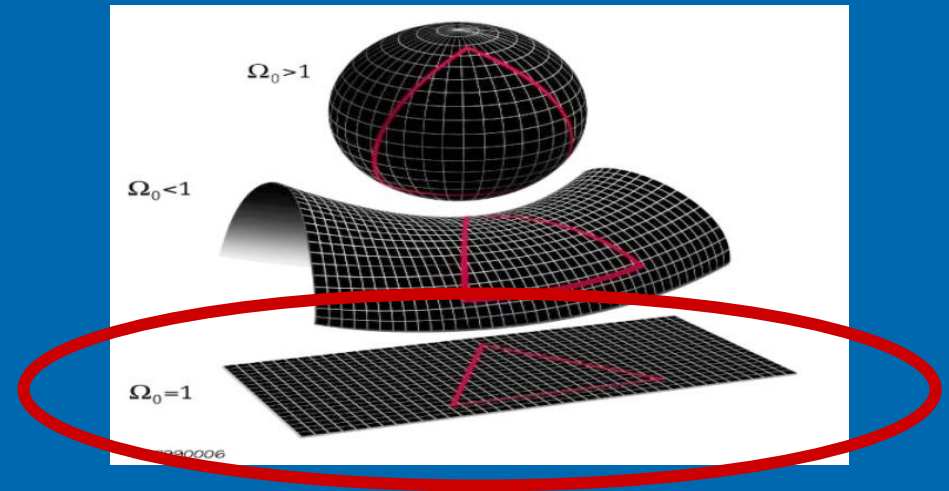
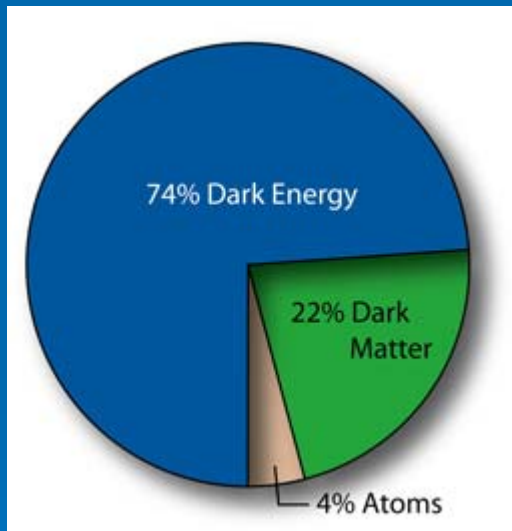

Cosmological concordance model

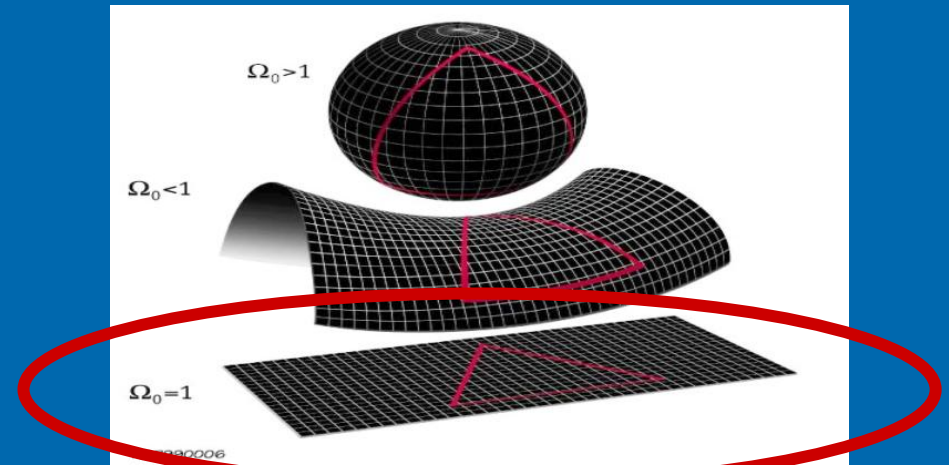
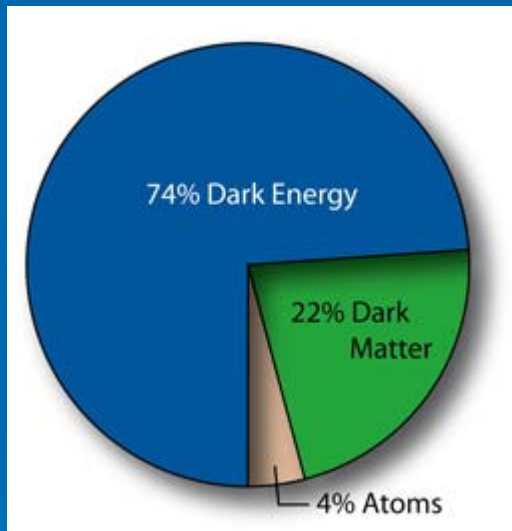

CMB anisotropy statistics: unknown, probably still hidden by systematics

- Evidence for North south asymmetry (Hansen et al. 2005)
- Evidence for Bianchi models (Jaffe et al. 2006)
- Poor constraints on inflation, the error is about 100 times the predicted deviations from Gaussianity (Komatsu et al. 2003)
- Lensing detection out of reach

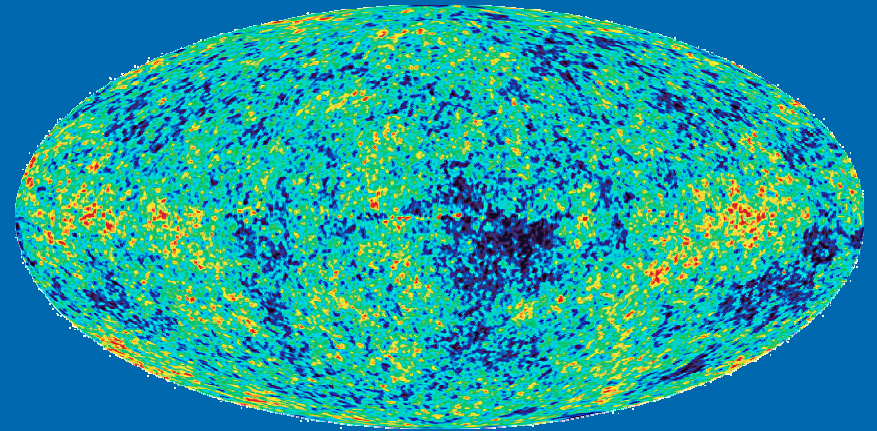

Other cosmological backgrounds?

- Neutrinos: abundance comparable to photons ☺, decoupling at MeV ☺, cold as photons ☹, weak interaction ☹
- Gravity waves: decoupling at Planck energy ☺, abundance unknown ☹, gravitational interaction ☹
- Morale: insist with the CMB, still for many years...that's the best we have for long...

Forthcoming CMB polarization probes

- Planck
- EBEx (NASA, France, Italy, UK), balloon, same launch time scale as Planck for the north american flight
- QUIET (US, UK), ground based
- Clover (UK, ...)
- Brain
- ...
- Complete list available at lambda.gsfc.nasa.gov

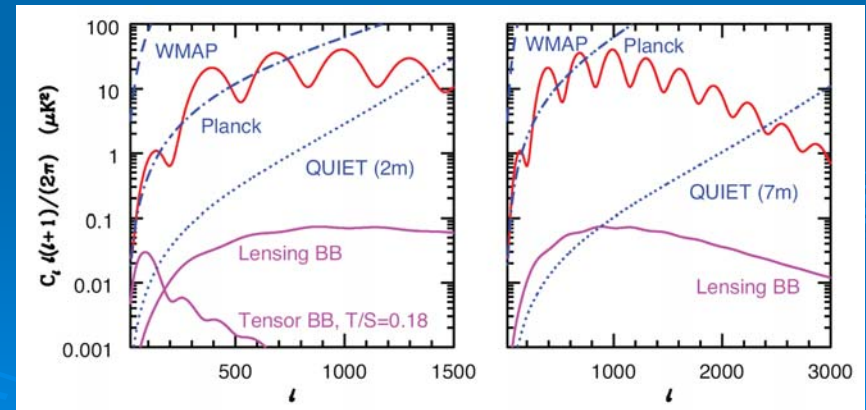
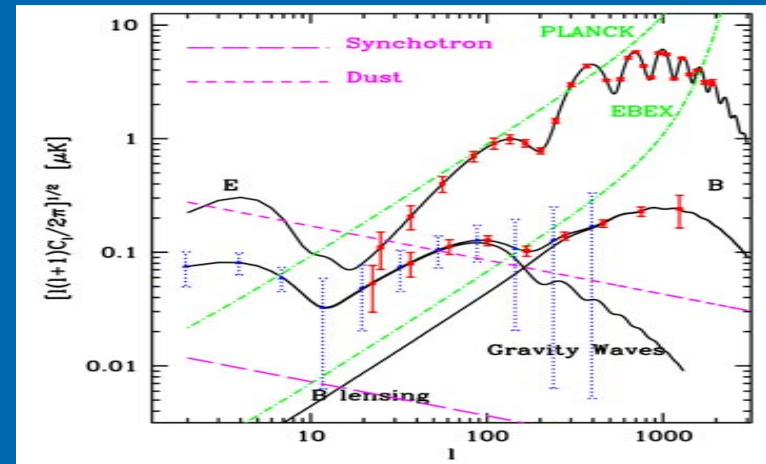

Cosmic vision beyond Einstein

- NASA and ESA put out separate calls of opportunity for a polarization oriented future (2020 or so) CMB satellite
- Technologies, design, options for joint or separate missions are being discussed in these months
- Promises: gravity waves, lensing and high redshift dark energy, inflationary non-Gaussianity

Cosmic vision program logo

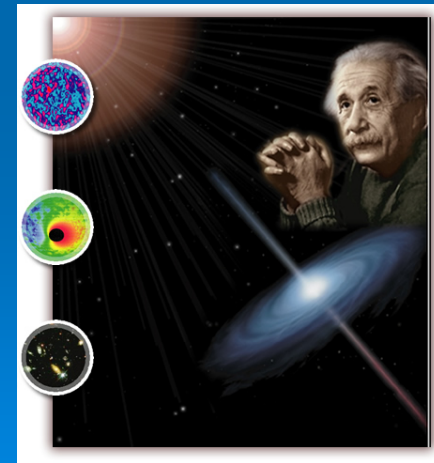

Beyond Einstein logo

Challenges for future CMB



Challenges for future CMB

- The sensitivity can be increases with the detector number 😊
- The systematics from the instrument must be controlled at the level of the signal 😞
- The emission from foregrounds may cover the B signal over the all sky, at all frequency 😞

Jarosik et al. 2006

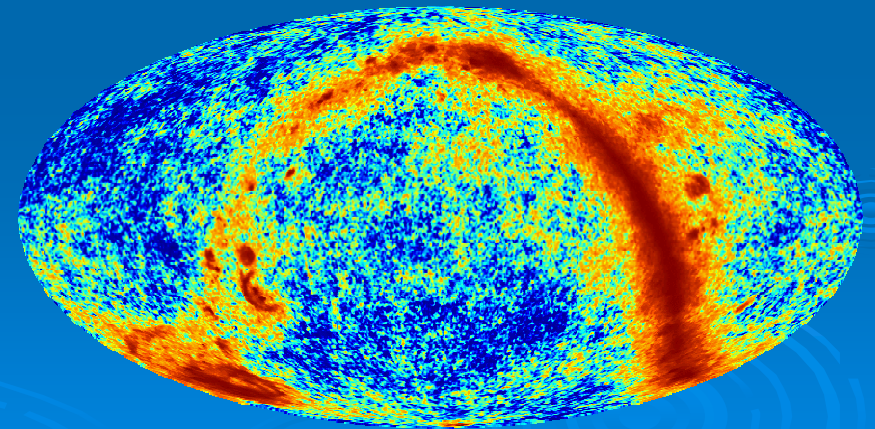
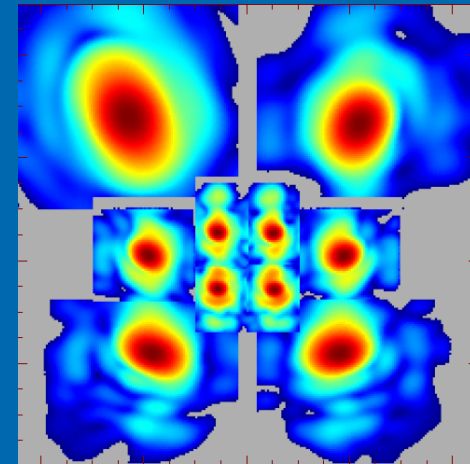

Challenges for future CMB: systematics from beam shape

- Asymmetric beams cause unwanted polarization from total intensity, leakage of E modes into B, ...
- No way to circularize the beams, rather the beam shape has to be reconstructed in flight to subtract the bias from the signal

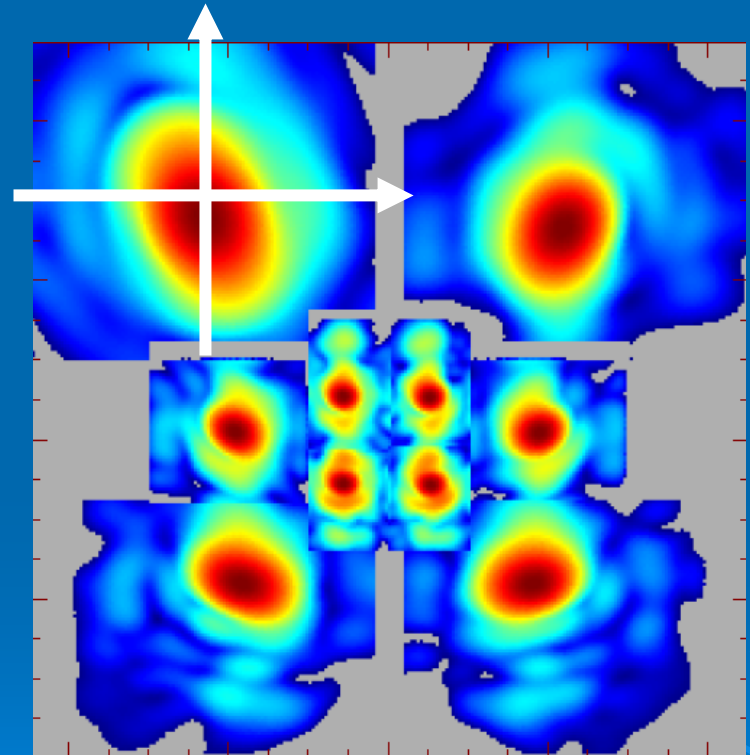

Challenges for future CMB: foreground emission

Bennett et al. 2006

- In total intensity, at frequencies between 60 and 90 GHz, after cutting out the brightest part of the Galactic emission, the sky is dominated by CMB

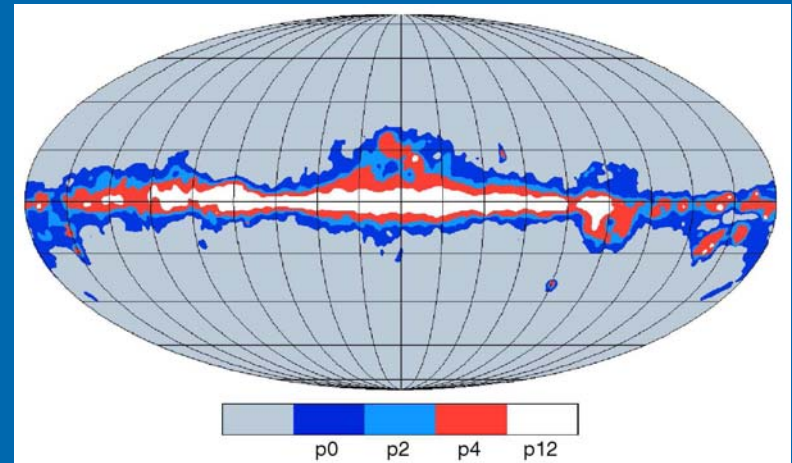

Challenges for future CMB: foreground emission

Bennett et al. 2006

- In total intensity, at frequencies between 60 and 90 GHz, after cutting out the brightest part of the Galactic emission, the sky is dominated by CMB
- In polarization, at frequencies between 60 and 90 GHz, after cutting out the brightest part of the Galactic emission, the sky is dominated by CMB

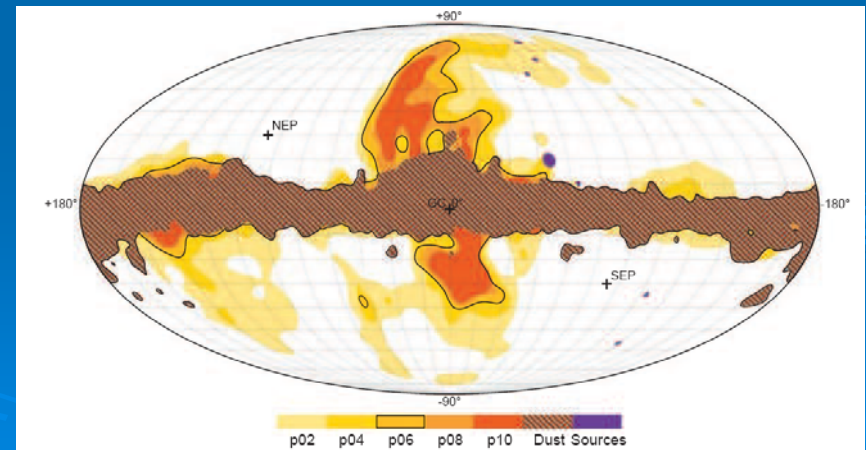
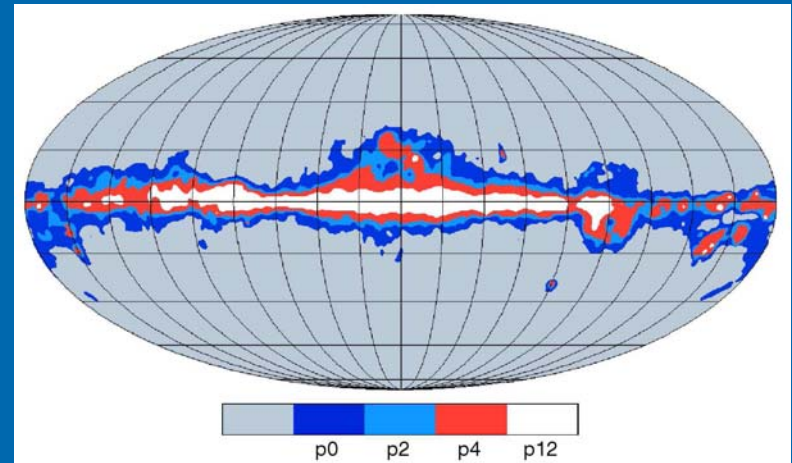

Page et al. 2006

Challenges for future CMB: foreground emission

Bennett et al. 2006

- In total intensity, at frequencies between 60 and 90 GHz, after cutting out the brightest part of the Galactic emission, the sky is dominated by CMB polarization, at frequencies between 60 and 90 GHz, after cutting out the brightest part of the Galactic emission, the sky is dominated by CMB

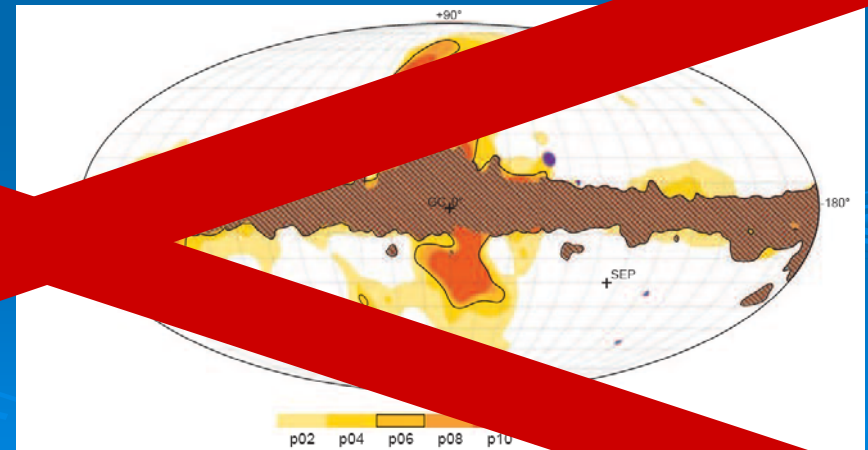
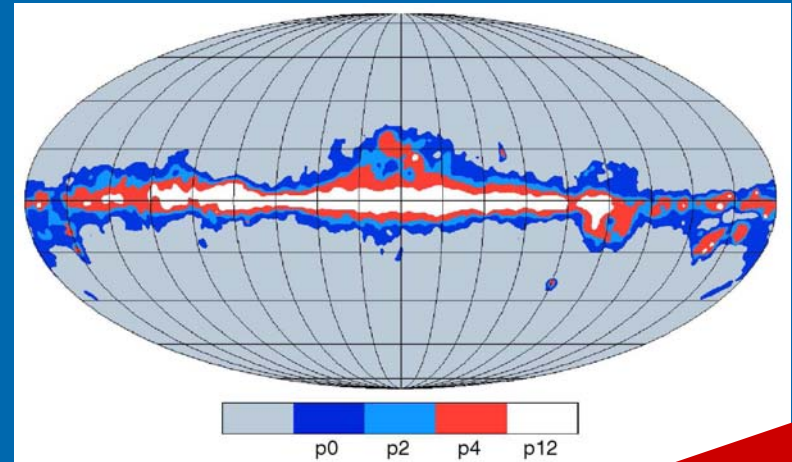

Challenges for future CMB: foreground emission

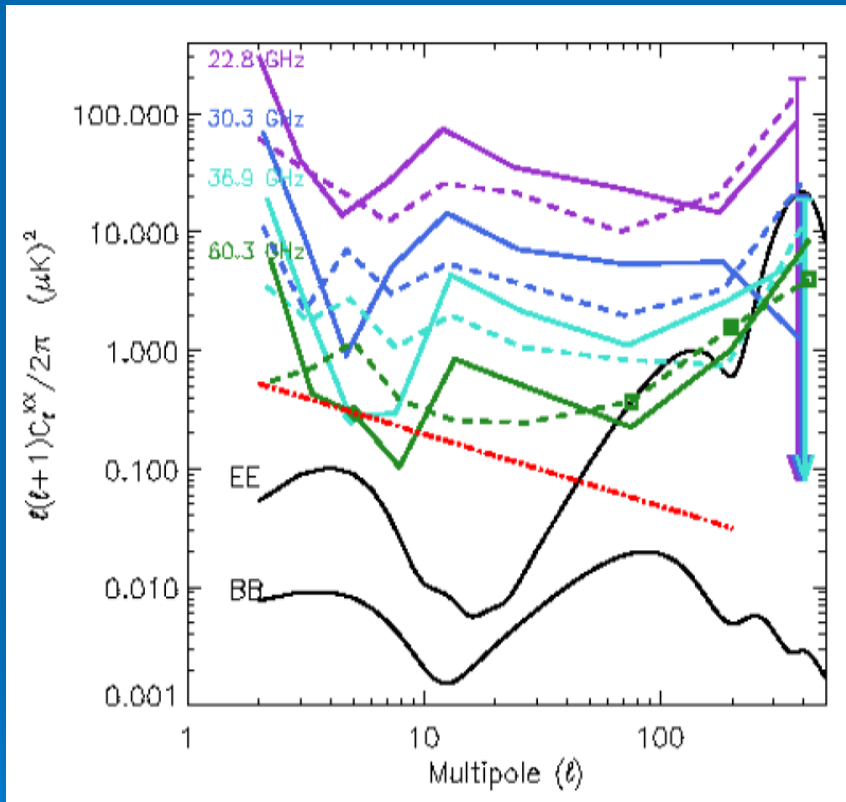

Page et al. 2006

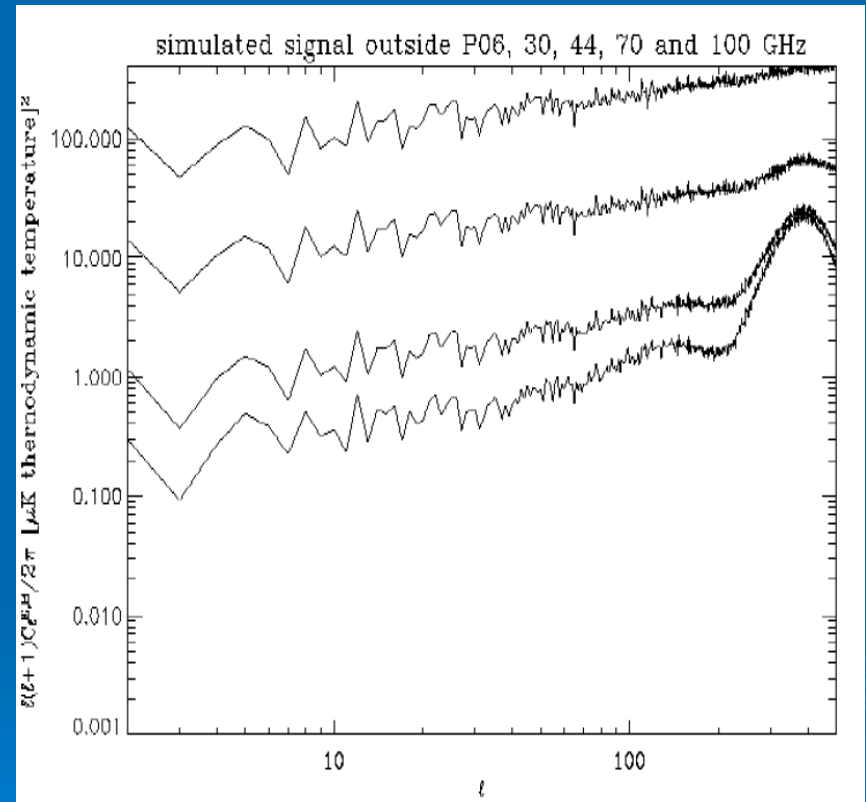

Planck reference sky

Are there foreground clean regions at all in polarization?

Page et al. 2006

- WMAP has no detection in large sky areas in polarization
- Very naive estimates may be attempted in those areas, indicating that the foreground level might be comparable to the cosmological B mode at all frequencies, in all sky regions

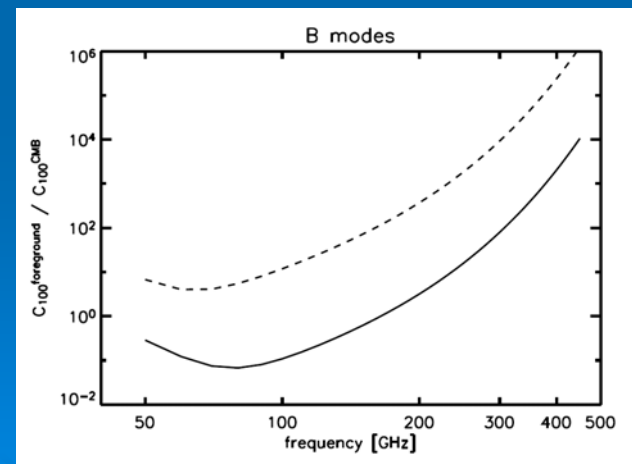
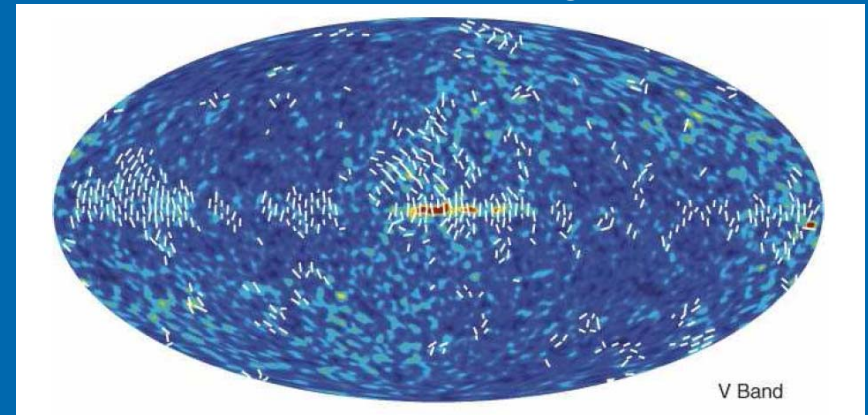

Living with foregrounds: component separation

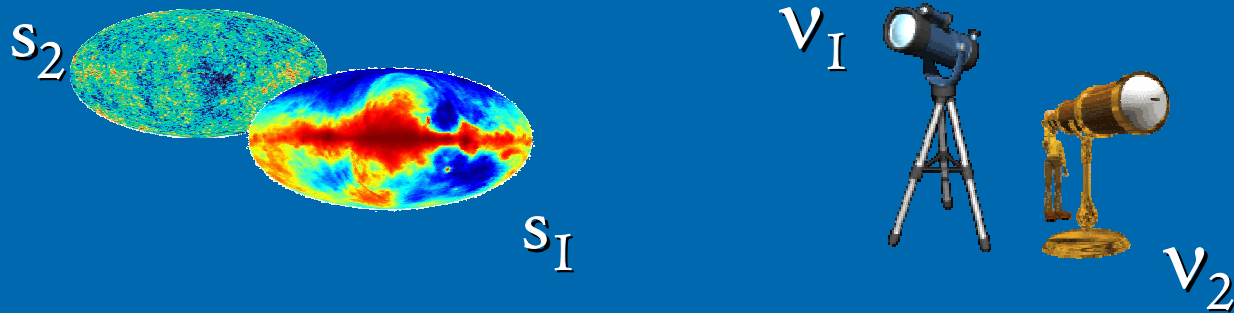

$$x_1 = a_{11} s_1 + a_{12} s_2 + n_1$$

$$x_2 = a_{21} s_1 + a_{22} s_2 + n_2$$

Living with foregrounds: component separation

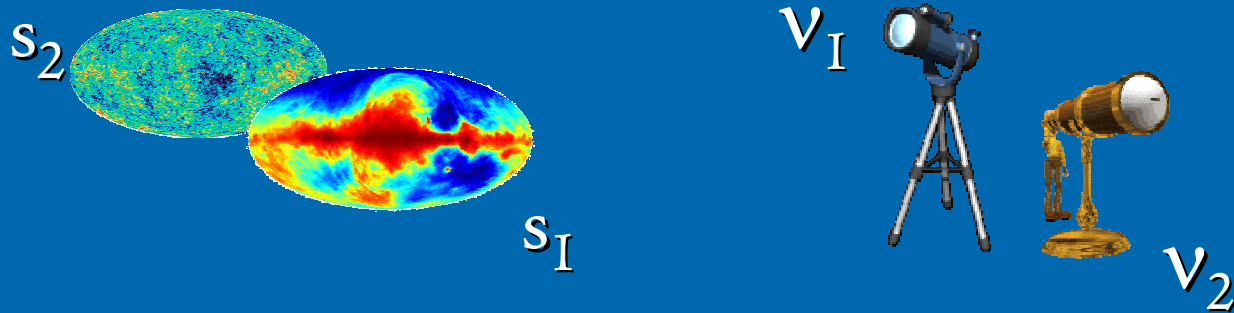

$$x_1 = a_{11} s_1 + a_{12} s_2 + n_1$$

$$x_2 = a_{21} s_1 + a_{22} s_2 + n_2$$

Living with foregrounds: component separation

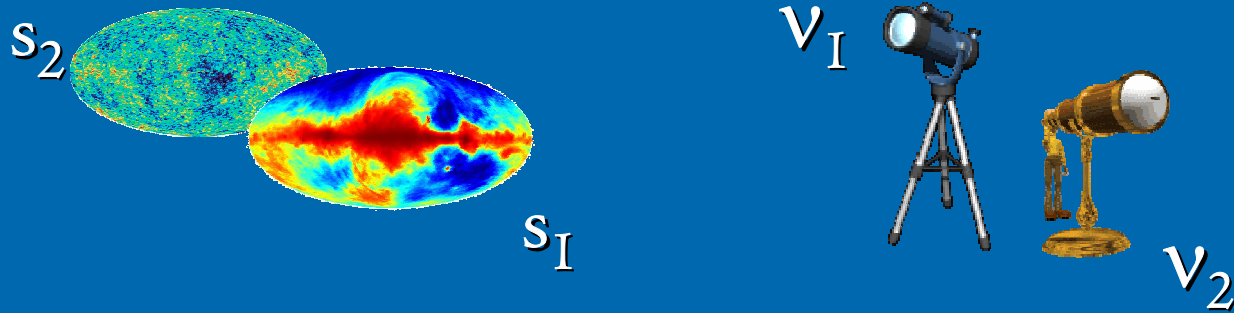

$$\mathbf{x} = \mathbf{A}\mathbf{s} + \mathbf{n}$$

Invert for \mathbf{s} !

Living with foregrounds: component separation

$$x = As + n$$

- Non-blind approach: use prior knowledge on A and s in order to stabilize the inversion, likely to be suitable for total intensity
- Blind approach: do not assume any prior either on A or s , likely to be used in polarization
- Relevant literature from Brandt et al. 1994, to Maino et al. 2006, successful applications to COBE, BEAST, WMAP

Component separation in polarization

- Component separation studies how to separate CMB and foregrounds in astrophysical multi-frequency observations
- The independent component analysis exploits the statistical differences between the almost Gaussian CMB and the strongly non-Gaussian foregrounds
- Results are encouraging, although obtained so far without instrumental systematics

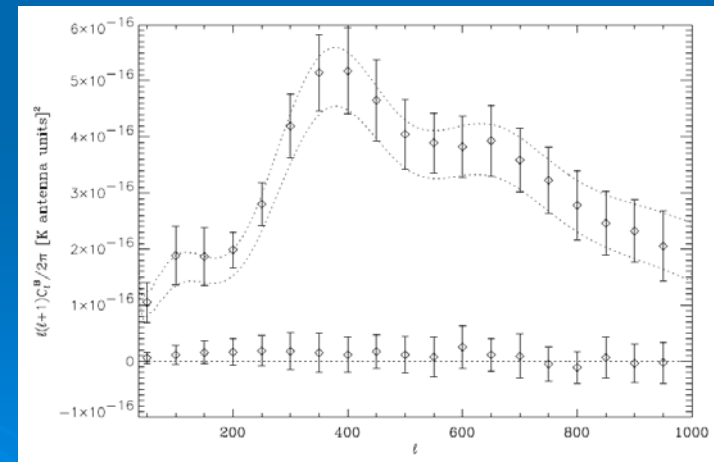
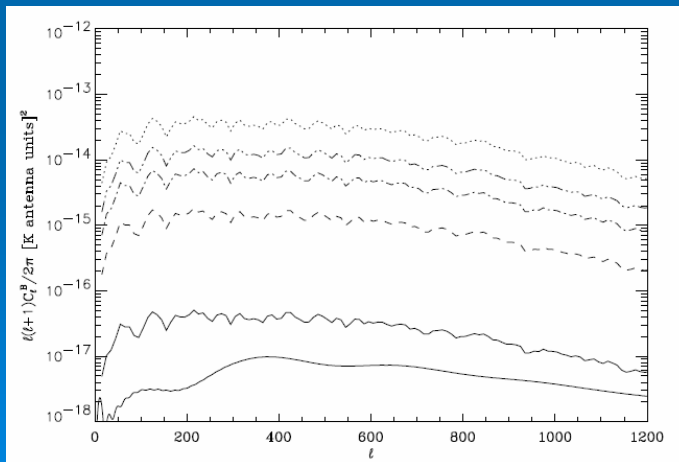
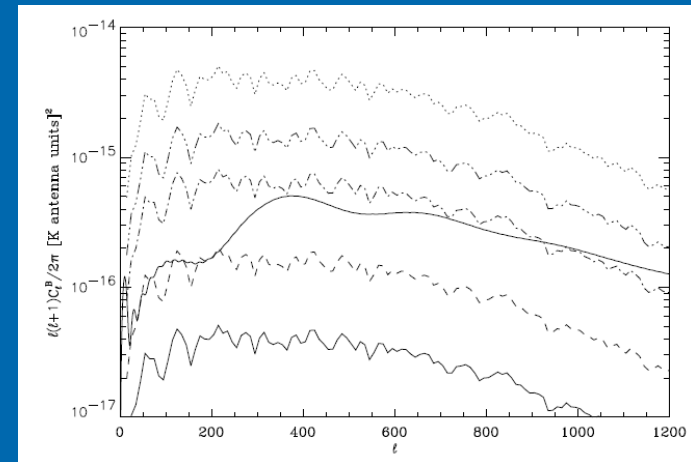

Stivoli et al. 2006

The science goals of the Planck satellite

Source: Planck scientific program bluebook,
available at www.rssd.esa.int/Planck



Planck

- Hardware: third generation CMB probe, ESA medium size mission, NASA (JPL, Pasadena) contribution
- Software from 400 collaboration members in EU and US
- Two data processing centers (DPCs): Paris + Cambridge (IaP + IoA), Trieste (OAT + SISSA)

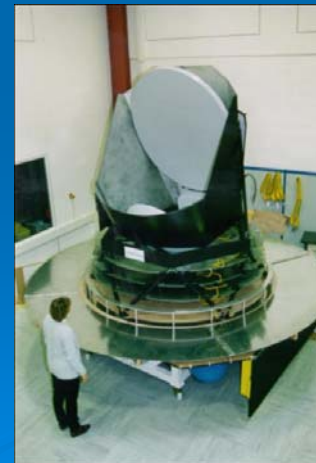
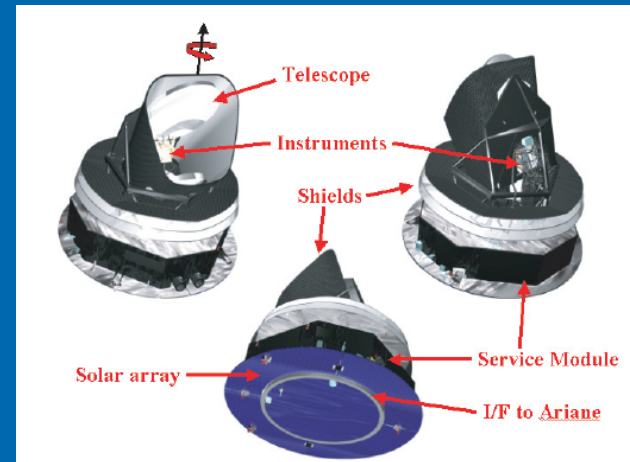

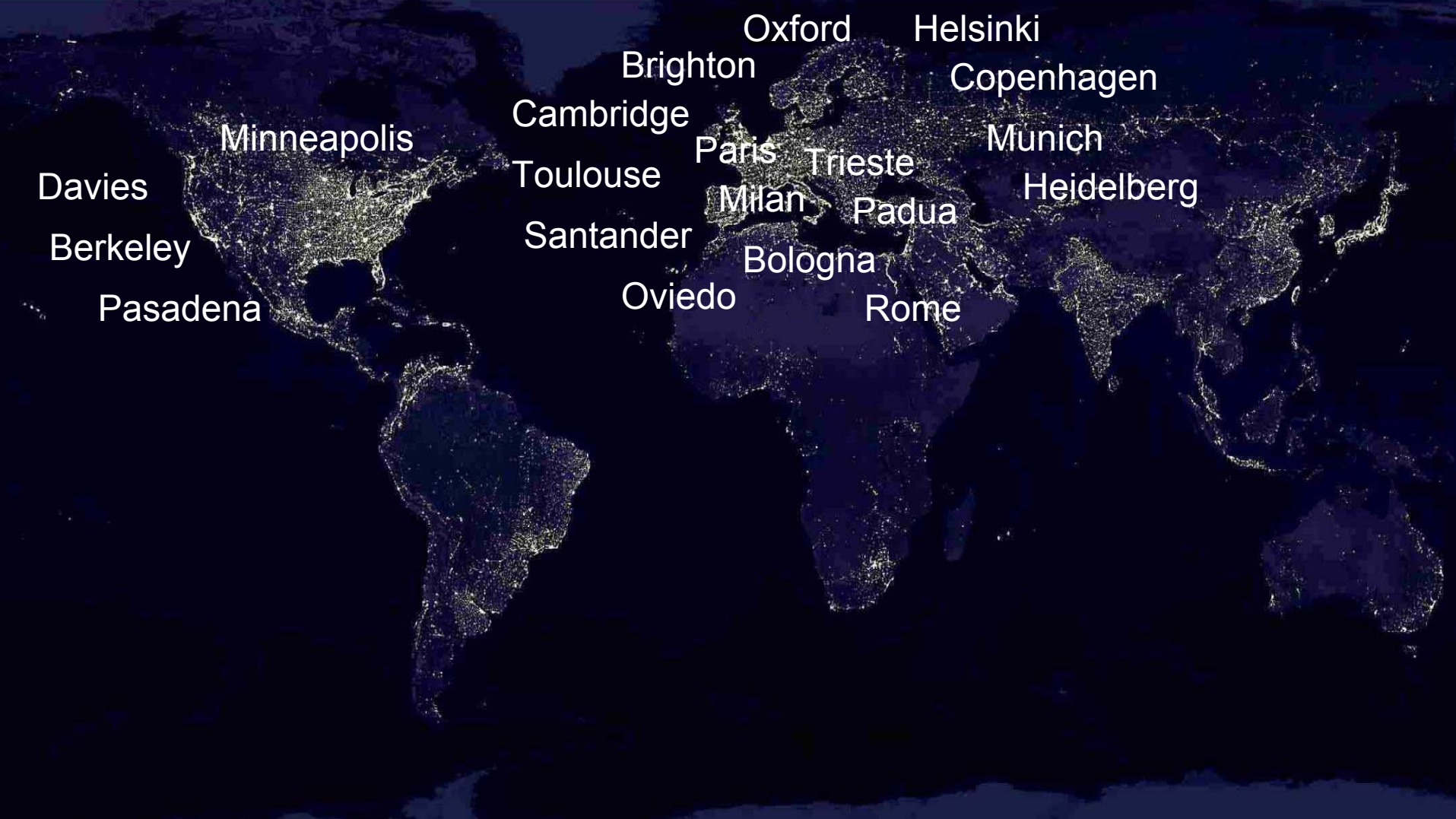

Planck contributors

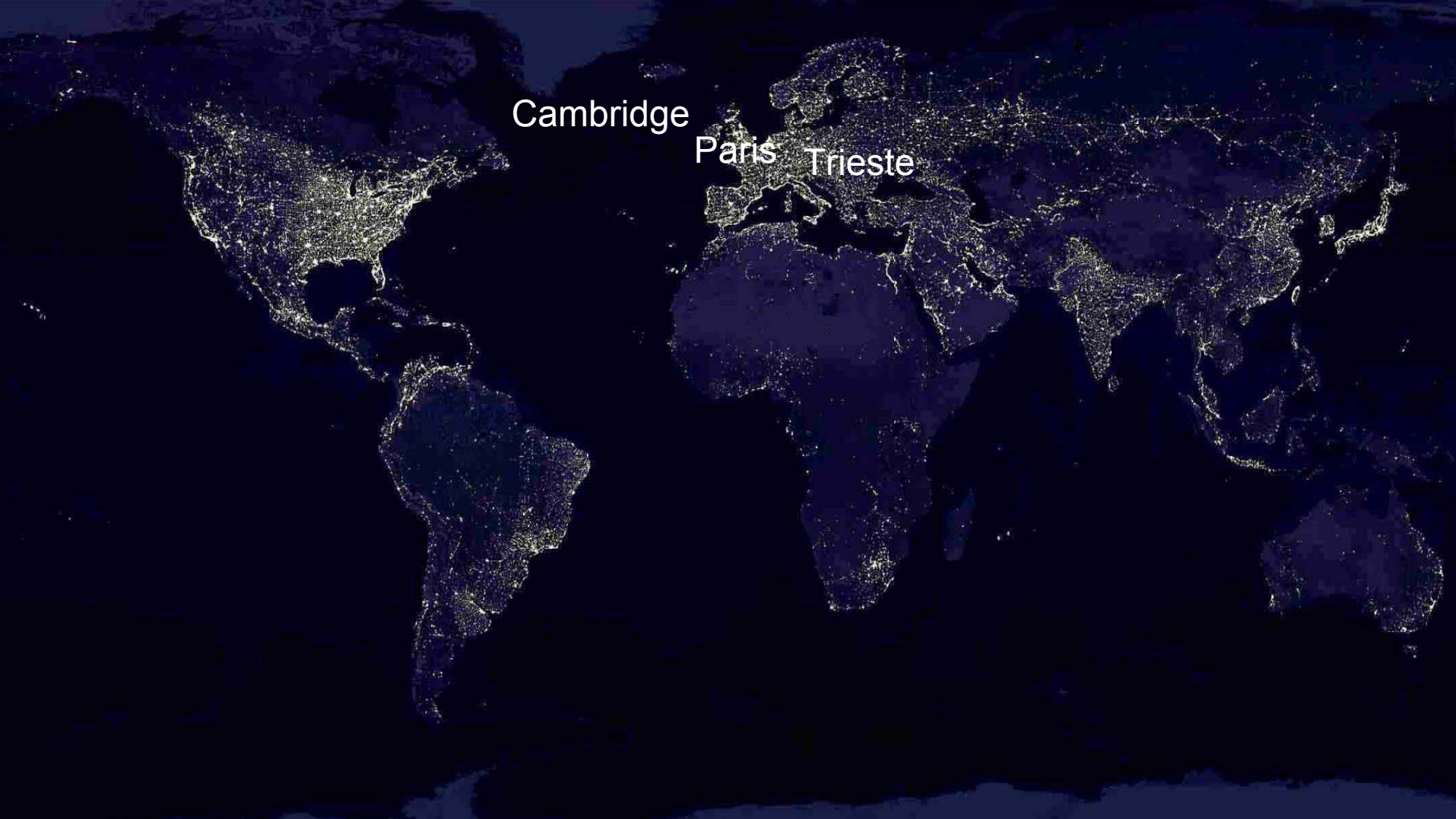

Cambridge

Paris

Trieste

Planck data processing sites

Planck data deliverables

- All sky maps in total intensity and polarization, at 9 frequencies between 30 and 857 GHz
- Angular resolution from 33' to 7' between 30 and 143 GHz, 5' at higher frequencies
- S/N ≈ 10 for CMB in total intensity, per resolution element
- Catalogues with tens of thousands of extra-Galactic sources

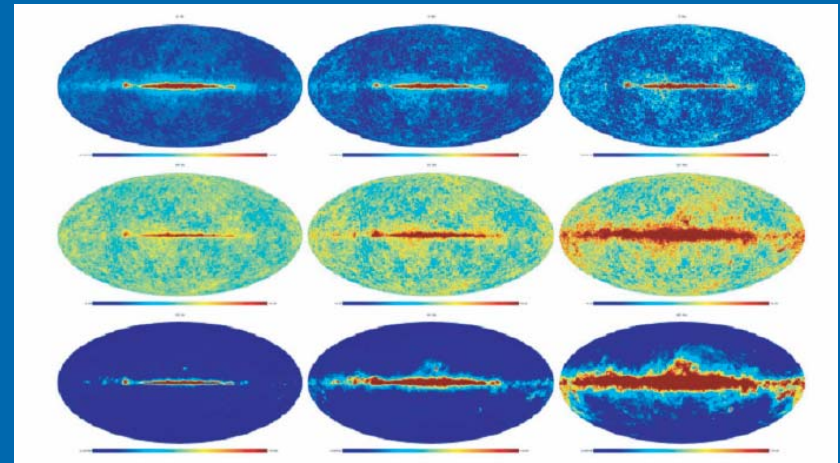

| PLANCK GALAXY SURVEYS | | | | | |
|---|-----------------|------|------|------|-------|
| | FREQUENCY [GHz] | | | | |
| | 143 | 217 | 353 | 550 | 850 |
| Confusion limit [mJy, 3σ] | 6.3 | 14.1 | 44.7 | 112 | 251 |
| Planck All Sky Survey sensitivity [mJy, 3σ] | 26 | 37 | 75 | 180 | 300 |
| Planck Deep Survey sensitivity [mJy, 3σ] | 10 | 18.4 | 49 | 170 | 280 |
| Number of galaxies [all sky] | 570 | 860 | 1700 | 4400 | 35000 |

Planck scientific deliverables: CMB total intensity and the era of imaging

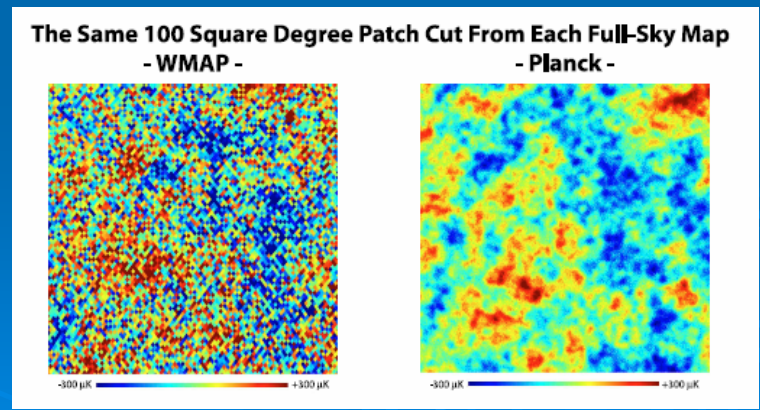
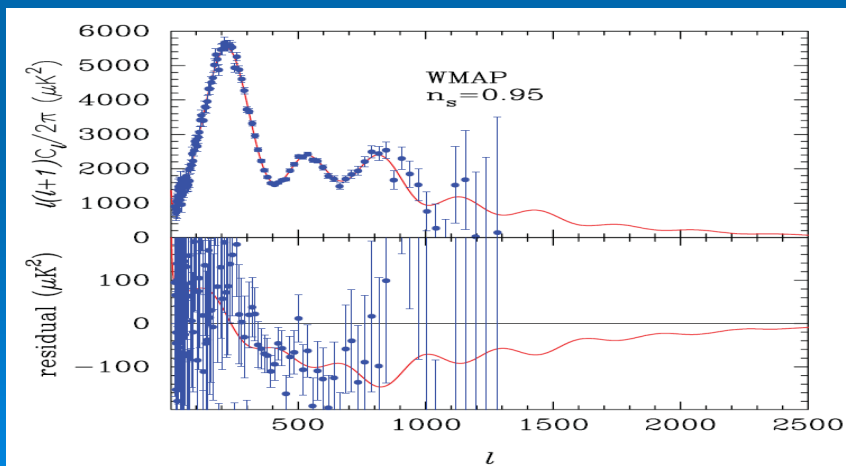
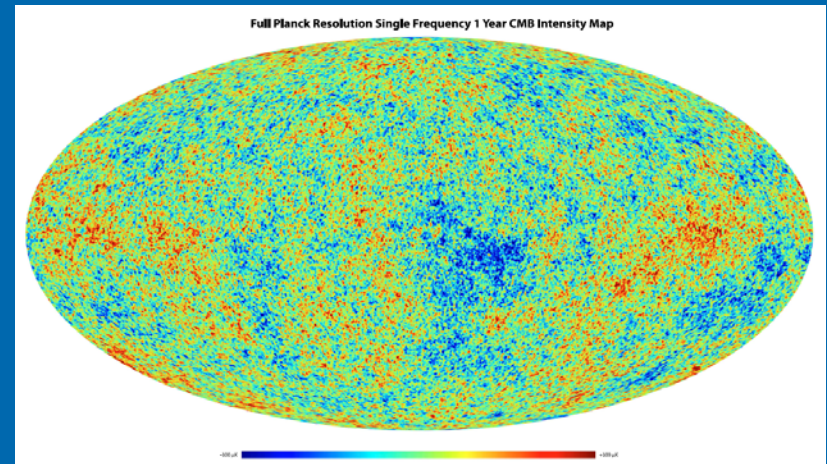
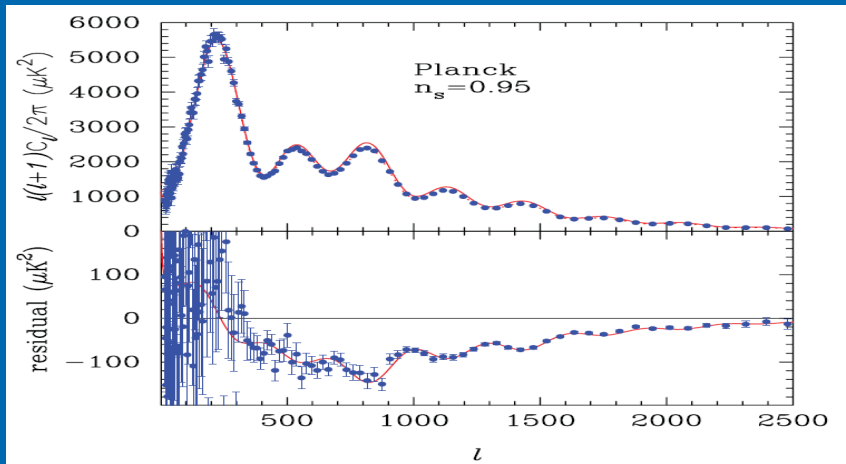

Planck scientific deliverables: CMB polarization

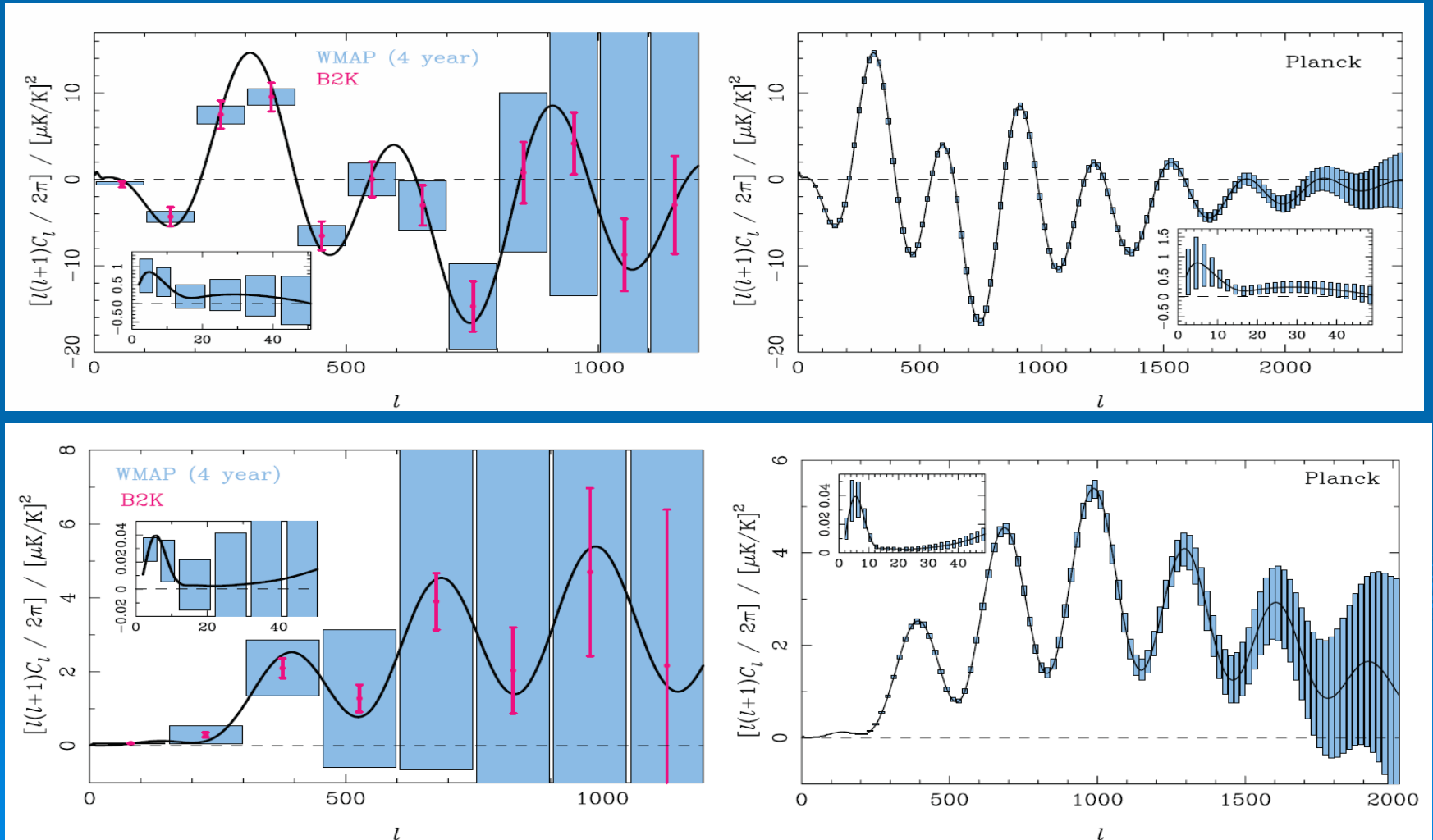

Planck and polarization CMB B modes

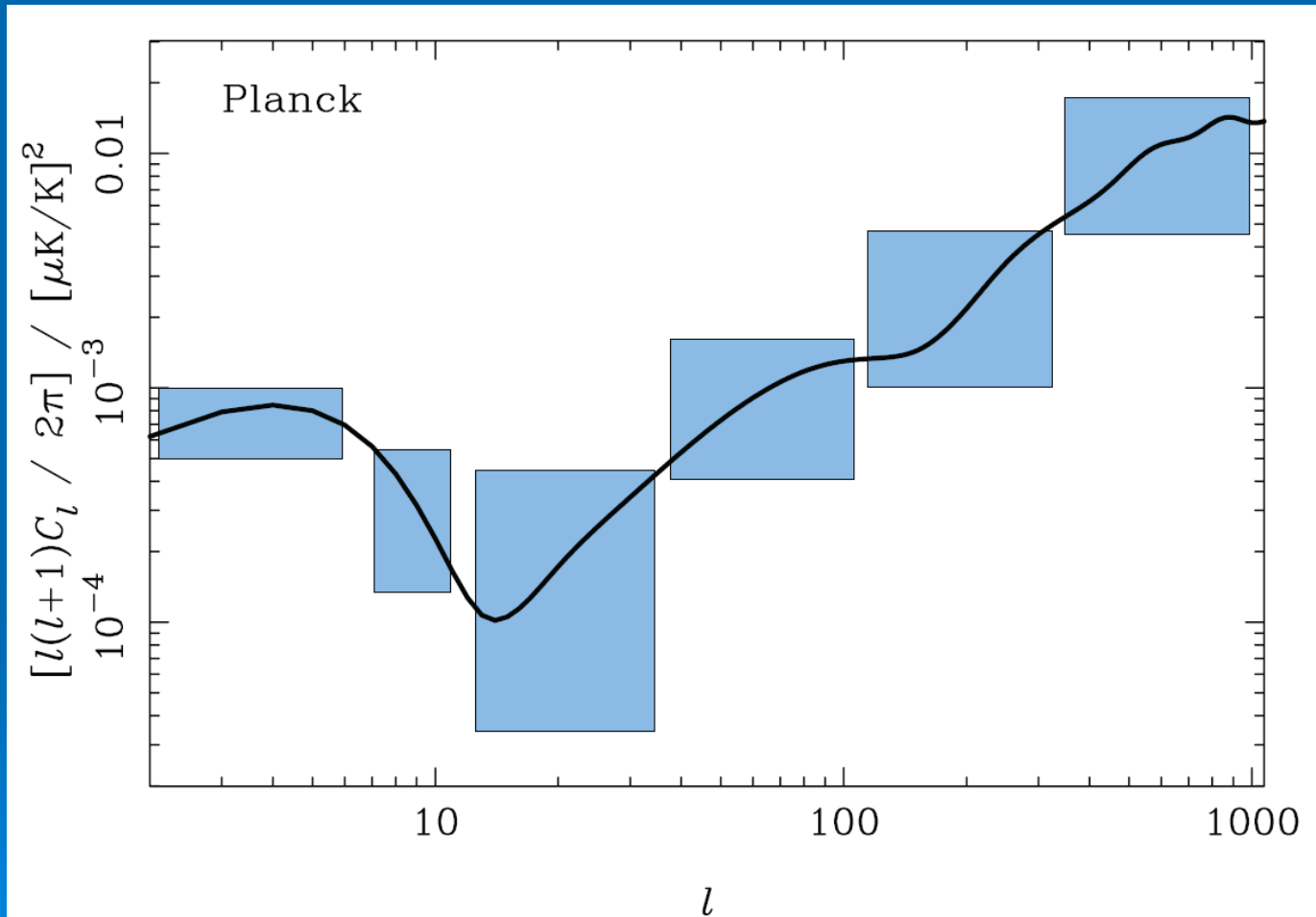

Planck scientific deliverables: cosmological parameters

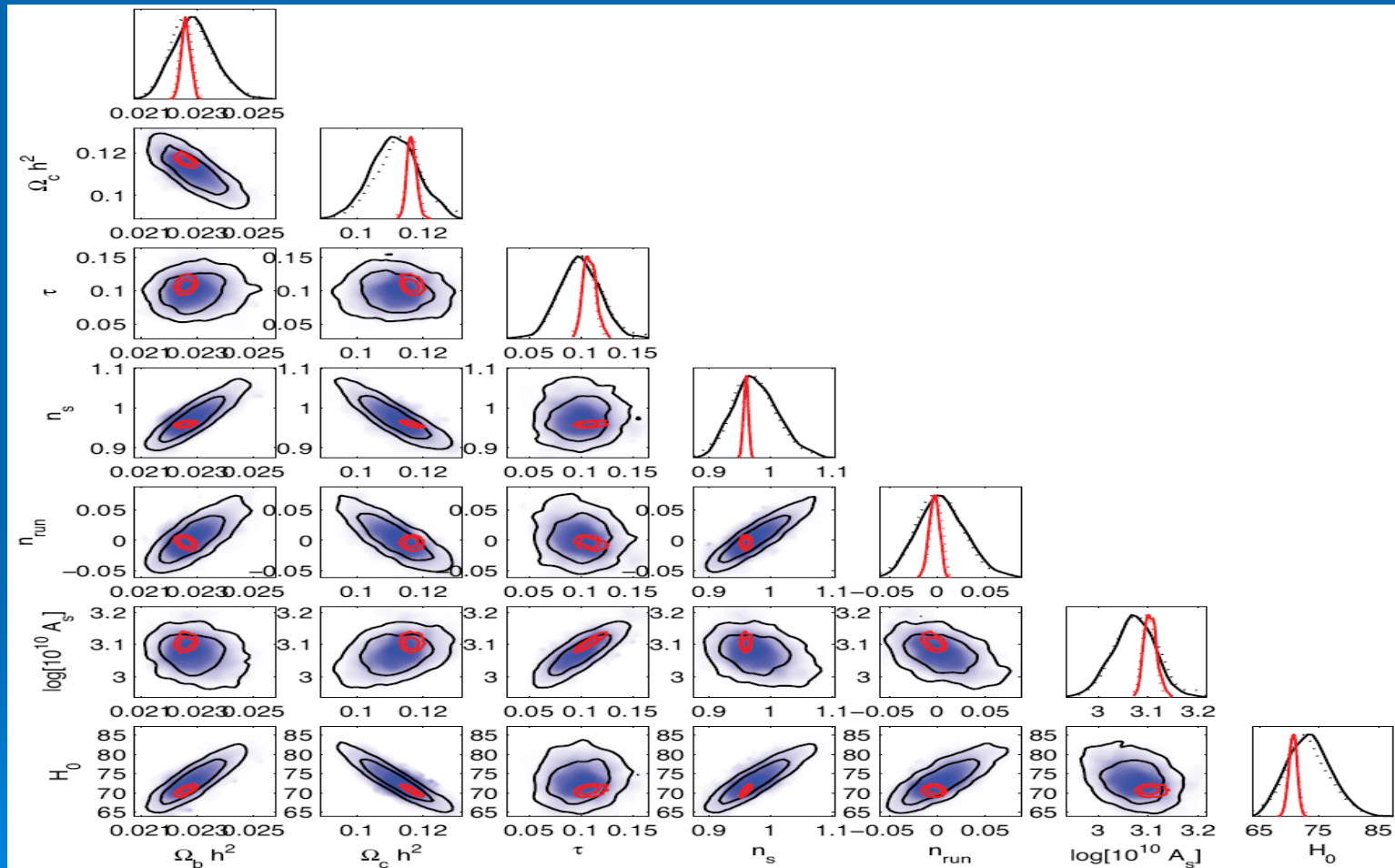

Non-CMB Planck scientific deliverables

- Thousands of galaxy clusters
- Tens of thousands of radio and infrared extra-Galactic sources
- Templates for the diffuse gas in the Galaxy, from 30 to 857 GHz
- ...



Conclusions

- The CMB will be the best signal from the early universe for long
- We have some knowledge of the two point correlation function, but most of the signal is presently unknown
- If detected, the hidden signatures might reveal mysteries for physics, like gravitational waves, or the mechanism of cosmic acceleration
- We don't know if we will ever see those things, systematics and foregrounds might prevent that
- But we've no other way to get close to the Big Bang, so let's go for it and see how far we can go
- First go/no go criteria from Planck and other probes in just a few years, possible scenarios...



- Polarized foreground too intense, no sufficient cleaning, systematics out of control
- Increase by one digit the cosmological parameters measurement, mostly from improvements in total intensity measurements
- Time scale: few years



- Modest or controllable foreground emission, systematics under control
- Cosmological gravity waves discovered from CMB B modes! Expected precision down to one thousandth of the scalar amplitude
- Percent measurement of the dark energy abundance at the onset of acceleration, from CMB lensing
- Time scale: 10 years